



FIRST® ENERGIZE<sup>SM</sup>  
presented by Qualcomm

2023 FIRST® Robotics Competition

# Game Manual



## Contents

1	Introduction.....	6
1.1	About <i>FIRST</i> ® .....	6
1.2	In Memoriam .....	6
1.3	<i>FIRST</i> ® Robotics Competition .....	6
1.4	<i>Gracious Professionalism</i> ®, a <i>FIRST</i> Credo.....	7
1.5	<i>Coopertition</i> ® .....	8
1.6	Spirit of Volunteering .....	9
1.7	This Document & Its Conventions.....	10
1.8	Translations & Other Versions .....	12
1.9	Team Updates .....	12
1.10	Question and Answer System .....	12
2	<i>FIRST</i> Season Overview .....	14
3	Game Sponsor Recognition.....	15
4	Game Overview.....	16
5	ARENA.....	17
5.1	FIELD.....	17
5.2	Areas, Zones, and Markings .....	20
5.3	BARRIER.....	22
5.4	CHARGE STATION .....	22
5.4.1	CHARGE STATION lighting.....	24
5.5	GRID .....	25
5.6	SUBSTATIONS.....	28
5.6.1	SINGLE SUBSTATION .....	29
5.6.2	DOUBLE SUBSTATION.....	30
5.7	ALLIANCE WALLS .....	32
5.7.1	DRIVER STATIONS.....	33
5.8	GAME PIECES.....	36
5.8.1	CONE .....	36
5.8.2	CUBE.....	37
5.8.3	GAME PIECE Holders .....	37
5.9	Vision Targets .....	38

---

5.9.1	Reflective Tape .....	39
5.9.2	AprilTags .....	40
5.10	The FIELD Management System.....	42
6	MATCH Play.....	43
6.1	Setup.....	43
6.1.1	GAME PIECES .....	43
6.1.2	ROBOTS.....	43
6.1.3	Humans .....	44
6.2	Autonomous Period .....	44
6.3	Teleoperated Period.....	44
6.4	Scoring.....	44
6.4.1	GRID Scoring .....	45
6.4.2	CHARGE STATION Scoring .....	46
6.4.3	Point Values .....	46
6.5	Rule Violations .....	47
6.5.1	Violation Details.....	48
6.6	DRIVE TEAM .....	48
6.7	Other Logistics .....	50
7	Game Rules: ROBOTS .....	51
7.1	ROBOT Restrictions .....	51
7.2	ROBOT to ROBOT Interaction.....	54
7.3	FIELD Interaction.....	58
7.4	GAME PIECES.....	59
8	Game Rules: Humans.....	61
8.1	General.....	61
8.2	REFEREE Interaction .....	64
8.3	Before/After the MATCH .....	65
8.4	During the MATCH: AUTO.....	69
8.5	During the MATCH .....	70
9	ROBOT Construction Rules .....	72
9.1	General ROBOT Design .....	74
9.2	ROBOT Safety & Damage Prevention.....	76
9.3	Budget Constraints & Fabrication Schedule.....	77
9.4	BUMPER Rules .....	81

---

9.5	Motors & Actuators.....	88
9.6	Power Distribution.....	92
9.7	Control, Command & Signals System.....	100
9.8	Pneumatic System.....	104
9.9	OPERATOR CONSOLE.....	108
10	Inspection & Eligibility Rules.....	110
10.1	Rules.....	110
11	Tournaments.....	114
11.1	MATCH Schedules.....	114
11.2	Head REFEREE and FTA Interaction.....	114
11.2.1	Question Box.....	114
11.2.2	YELLOW and RED CARDS.....	115
11.2.3	YELLOW and RED CARD application.....	115
11.2.4	YELLOW and RED CARDS during Playoff MATCHES.....	116
11.3	MATCH Replays.....	116
11.4	Measurement.....	117
11.5	Practice MATCHES.....	117
11.5.1	Filler Line.....	118
11.6	Qualification MATCHES.....	118
11.6.1	Schedule.....	118
11.6.2	MATCH Assignment.....	118
11.6.3	Qualification Ranking.....	119
11.7	Playoff MATCHES.....	119
11.7.1	ALLIANCE Selection Process.....	119
11.7.2	Playoff MATCH Bracket.....	120
11.7.3	BACKUP TEAMS.....	123
11.7.4	LINEUPS.....	124
11.7.5	Pit Crews.....	125
11.7.6	Small Event Exceptions.....	125
11.8	Advancement Through the District Model.....	126
11.8.1	District Events.....	126
11.8.2	District Championship Eligibility.....	129
11.8.3	District Championships with Multiple Divisions.....	130
11.9	FIRST Championship: Additions and Exceptions.....	132



---

11.9.1	Advancement to the <i>FIRST</i> Championship .....	132
11.9.2	4 ROBOT ALLIANCES .....	132
11.9.3	<i>FIRST</i> Championship Pit Crews .....	133
11.9.4	<i>FIRST</i> Championship Playoffs .....	133
12	Glossary .....	135

# 1 INTRODUCTION

## 1.1 About FIRST®

*FIRST*® (For Inspiration and Recognition of Science and Technology) was founded by inventor Dean Kamen to inspire young people's interest in science and technology. As a robotics community that prepares young people for the future, *FIRST* is the world's leading youth-serving nonprofit advancing STEM education. For 30 years, *FIRST* has combined the rigor of STEM learning with the fun and excitement of traditional sports and the inspiration that comes from community through programs that have a proven impact on learning, interest, and skill-building inside and outside of the classroom. *FIRST* provides programs that span a variety of age groups:

- *FIRST*® Robotics Competition for grades 9-12, ages 14-18
- *FIRST*® Tech Challenge for grades 7-12, ages 12-18
- *FIRST*® LEGO® League for grades Pre-K-8, ages 4-16
  - *FIRST*® LEGO® League Challenge for grades 4-8 (ages 9-16, ages vary by country)
  - *FIRST*® LEGO® League Explore for grades 2-4 (ages 6-10)
  - *FIRST*® LEGO® League Discover for grades Pre-K-1 (ages 4-6)

Please visit [the FIRST website](#) for more information about *FIRST* and its programs.

## 1.2 In Memoriam

In October 2019, Dr. Woodie Flowers, an innovator in design and engineering education and a Distinguished Advisor to *FIRST* and supporter of our mission, passed away. As thousands of heartfelt tributes to Woodie have poured in from around the world, it is clear his legacy will live on indefinitely through the gracious nature of our community and our ongoing commitment to empowering educators and building global citizens.

*Figure 1-1 Dr. Woodie Flowers, 1943-2019*



## 1.3 FIRST® Robotics Competition

*FIRST*® Robotics Competition combines the excitement of sport with the rigors of science and technology. Teams of students are challenged to design, build, and program industrial-size robots and compete for awards, while they also create a team identity, raise funds, hone teamwork skills, and advance respect and appreciation for STEM within the local community.

Volunteer professional mentors lend their time and talents to guide each team. It's as close to real-world engineering as a student can get. Plus, high school students gain access to exclusive scholarship opportunities from colleges, universities, and technical programs.

Each January at an event known as "Kickoff," a new, challenging game is introduced. These exciting competitions combine the practical application of science and technology with the fun, intense energy, and excitement of a championship-style sporting event. Teams are encouraged to display *Gracious Professionalism*<sup>®</sup>, help other teams, and cooperate while competing. This is known as *Coopertition*<sup>®</sup>.

In 2023, *FIRST* Robotics Competition is projected to reach approximately 80,000 high-school students representing approximately 3,300 teams. Teams come from nearly every state in the United States, as well as many other countries.

*FIRST* Robotics Competition teams will participate in 61 Regional Competitions, 94 District Competitions, and 11 District Championships. In addition, approximately 600 teams will qualify to attend the *FIRST* Championship in April 2023.

This year's game, and this manual, were presented at the 2023 *FIRST* Robotics Competition Kickoff on Saturday, January 7, 2023.

At the Kickoff, all teams:

- saw the 2023 game, CHARGED UP<sup>SM</sup> presented by Haas, for the first time,
- learned about the 2023 game rules and regulations, and
- received a Kickoff Kit that provides a starting point for ROBOT build.

Safety is always paramount, and many rules are intended to establish norms at each event that will mitigate injury risk to all participants.

Event staff have the final decision authority for all safety-related issues within a venue.

Please refer to [FIRST Robotics Competition District and Regional Event web page](#) for safety, conduct, etc. rules not specific to CHARGED UP or limited to MATCH play. As with all violations in this document, any event rules also carry the potential consequence of a YELLOW or RED CARD.

## 1.4 *Gracious Professionalism*<sup>®</sup>, a *FIRST* Credo

*Gracious Professionalism*<sup>®</sup> is part of the ethos of *FIRST*. It's a way of doing things that encourages high quality work, emphasizes the value of others, and respects individuals and the community.

*Gracious Professionalism* is not clearly defined for a reason. It can and should mean different things to everyone.

Some possible meanings of *Gracious Professionalism* include:

- gracious attitudes and behaviors are win-win,
- gracious folks respect others and let that respect show in their actions,
- professionals possess special knowledge and are trusted by society to use that knowledge responsibly, and
- gracious professionals make a valued contribution in a manner pleasing to others and to themselves.

In the context of *FIRST*, this means that all teams and participants should:

- learn to be strong competitors, but also treat one another with respect and kindness in the process and
- avoid leaving anyone feeling as if they are excluded or unappreciated.

Knowledge, pride, and empathy should be comfortably and genuinely blended.

In the end, *Gracious Professionalism* is part of pursuing a meaningful life. When professionals use knowledge in a gracious manner and individuals act with integrity and sensitivity, everyone wins and society benefits.



*The FIRST spirit encourages doing high-quality, well-informed work in a manner that leaves everyone feeling valued. Gracious Professionalism seems to be a good descriptor for part of the ethos of FIRST. It is part of what makes FIRST different and wonderful.*

*- Dr. Woodie Flowers, (1943 – 2019)  
Distinguished Advisor to FIRST*

It is a good idea to spend time going over this concept with your team and reinforcing it regularly. We recommend providing your team with real-life examples of *Gracious Professionalism* in practice, such as when a team loans valuable materials or expertise to another team that they will later face as an opponent in competition. Routinely highlight opportunities to display *Gracious Professionalism* at events and encourage team members to suggest ways in which they can demonstrate this quality themselves and through outreach activities.

## 1.5 **Coopertition**®

At FIRST, *Coopertition*® is displaying unqualified kindness and respect in the face of fierce competition. *Coopertition* is founded on the concept and philosophy that teams can and should help and cooperate with one another even as they compete. *Coopertition* involves learning from teammates and mentors. *Coopertition* means competing always but assisting and enabling others when you can.

### **Message from Woodie Flowers Award Recipients**

*The Woodie Flowers Award is the most prestigious mentoring award in FIRST. The award recipients created an important message for all FIRST Robotics Competition teams to consider as we tackle each season.*

*Performing at your best is important. Winning is important. This is a competition.*

*However, winning with Gracious Professionalism and being proud of what you have accomplished and how you have accomplished it is more important. FIRST could create rules and penalties to cover almost any scenario or situation, but we prefer an understandable game with simpler rules that allow us to think and be creative in our designs.*

*We want to know that our partners and opponents are playing at their best in every match. We want to know they are playing with integrity and not using strategies based on questionable behaviors.*

*As you create your robots and award presentations, prepare for competition and MATCH play, create and implement game strategies, and live your daily lives, remember what Woodie said time and time again, and let's 'Make your Grandmother proud.'*

Woodie Flowers	Paul Copioli (3310, 217)	Lane Matheson (932)
Liz Calef (88)	Rob Mainieri (812, 64, 498, 2735, 6833)	Mark Lawrence (1816)
Mike Bastoni (23)	Dan Green (111)	Eric Stokely (258, 360, 2557, & 5295)
Ken Patton (51, 65)	Mark Breadner (188)	Glenn Lee (359)
Kyle Hughes (27)	John Novak (16, 323)	Gail Drake (1885)
Bill Beatty (71)	Chris Fultz (234)	Allen Gregory (3847)
Dave Verbrugge (5110, 67)	John Larock (365)	Lucien Junkin (118)
Andy Baker (3940, 45)	Earl Scime (2614)	Matt Fagen (4253)
Dave Kelso (131)	Fredi Lajvardi (842)	Christine Sapiro (2486)

## 1.6 Spirit of Volunteering

### **2023 Season Spirit of Volunteering: A Message from the Chief Volunteers to the FIRST Community**

*There are two phrases which drive and motivate the individuals that volunteer their time for FIRST: "Giving Back" and "Pay It Forward". Each year, you have the opportunity to help create the best-ever experience for our mentors, coaches, students, and fellow volunteers. You can do this by volunteering at a FIRST event.*

*Volunteering has enormous, lifelong impacts for everyone involved. Every student, teacher, event volunteer, mentor, coach, and family member learns and grows throughout the season as they interact with each other. There are tremendous growth opportunities for all! Each volunteer takes their experiences, adds in the FIRST Core Values, and makes the decision to Pay It Forward by volunteering.*

*To our team members and mentors: remember that the volunteers you interact with are giving up their most precious asset - their time - to ensure that all teams have a fulfilling, fun, and memorable competition. Volunteers are the lifeblood of FIRST, and without them, FIRST would not be where it is today. We urge you to remember that Gracious Professionalism is part of the ethos of FIRST. It's a way of doing things that encourages high-quality work, emphasizes the value of others, and respects individuals and the community. We strive to train each volunteer to exhibit Gracious Professionalism at all times - we hope that you can reciprocate that behavior - and create an environment where all feel welcome.*

*To our loyal volunteers, and everyone else that is considering volunteering: we want to invite you to join us for the 2023 season. There's a lot to gain from volunteering and part of what makes it so much fun is:*

- *Seeing capable students learning and growing*
- *Making new friends with other awesome volunteers*
- *Being a part of the magic that makes an event happen*

- 
- *Sharing FIRST with folks who didn't know about it*
  - *Taking event experiences back to your team*
  - *Learning how to communicate with people outside of your normal circle*

*To our FIRST alumni: We need you! You know the impact of FIRST in your life and the opportunity you've been given. We're asking you to Give Back and help the next generation to have the same opportunity. The FIRST website has [great resources](#) for finding out how you can get involved by giving a few hours or more!*

*We look forward to welcoming you!*

*Chief Volunteer Coordinators – Laurie Shimizu & Sarah Plemmons*

*Chief FTAs – James Cerar and Mark McLeod*

*Chief Field Supervisors – Scott Goering & Ayla DeLaat*

*Chief Judge Advisors – Cindy Stong & Allen Bancroft*

*Chief Referees – Aidan Browne & Jon Zawislak*

*Chief Robot Inspectors - Al Skierkiewicz & Chuck Dickerson*

---

## 1.7 This Document & Its Conventions

---

The *2023 Game Manual* is a resource for all FIRST Robotics Competition teams for information specific to the 2023 season and the CHARGED UP<sup>SM</sup> presented by Haas game. Its audience will find the following detail:

- a general overview of the CHARGED UP game,
- detail about the CHARGED UP playing FIELD,
- a description of how to play the CHARGED UP game,
- game rules (related to safety, conduct, game play, inspection, etc.), and
- a description of how teams advance at 2023 tournaments and throughout the season

All participants should also study the [Event Rules Manual](#) as it details event rules and expectations that perpetuate from season to season. That content complements, and carries the same weight as, this document.

The intent of this manual is that the text means exactly, and only, what it says. Please avoid interpreting the text based on assumptions about intent, implementation of past rules, or how a situation might be in “real life.” There are no hidden requirements or restrictions. If you've read everything, you know everything.

Specific methods are used throughout this manual to highlight warnings, cautions, key words, and phrases. These conventions are used to alert the reader to important information and are intended help teams in constructing a ROBOT that complies with the rules in a safe manner.

Links to other section headings in this manual, external articles, and rule references appear in [blue underlined text](#).

Key words that have a particular meaning within the context of the FIRST Robotics Competition and CHARGED UP are defined in the Glossary section and indicated in ALL CAPS throughout this document.

The rule numbering method indicates the section, subsection, and position of the rule within that subsection. The letter indicates the section in which the rule is published.



- G for [Section 7 Game Rules: ROBOTS](#)
- H for [Section 8 Game Rules: Humans](#)
- R for [Section 9 ROBOT Construction Rules](#)
- I for [Section 10 Inspection and Eligibility Rules](#)
- T for [Section 11 Tournaments](#)

The following digit(s) represents the subsection in which the rule can be found. The final digits indicate the rule’s position within that subsection.

Figure 1-2 Rule numbering method

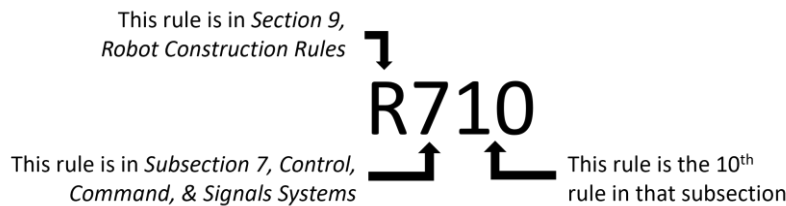

Warnings, cautions, and notes appear in blue boxes. Pay close attention to their contents as they’re intended to provide insight into the reasoning behind a rule, helpful information on understanding or interpreting a rule, and/or possible “best practices” for use when implementing systems affected by a rule.

While blue boxes are part of the manual, they do not carry the weight of the actual rule (if there is an inadvertent conflict between a rule and its blue box, the rule supersedes the language in the blue box).

Imperial dimensions are followed by comparable metric dimensions in parentheses to provide metric users with the approximate size, mass, etc. Metric conversions for non-rules (e.g. dimensions) round to the nearest whole unit, e.g. “17 in. (~43 cm)” and “6 ft. 4 in. (~193 cm).” Metric conversions in rules round such that the metric dimension is compliant with the rule (i.e. maximums round down, minimums round up). The metric conversions are offered for convenient reference only and do not overrule or take the place of the imperial dimensions presented in this manual and the official drawings (i.e. dimensions and rules will always defer to measurements using imperial units).

Rules include colloquial language, also called headlines, in an effort to convey an abbreviated version of the rule or rule set. There are two versions of headline formatting. Evergreen rules, or rules which are expected to go relatively unchanged from season to season, are indicated with a leading asterisk and their rule number and headline are presented in **bold green text**. “Relatively unchanged” means that the overall intent and presence of the rule from season to season is constant, but game specific terms may be updated as needed (e.g. changing Power Cells to GAME PIECES in a rule about what COACHES may not contact during a MATCH). These rules also start their respective section, so their rule number is not expected to change from season to season. All other rule headlines use **bold blue text**. Any disagreement between the specific language used in the rules and the colloquial language is an error, and the specific rule language is the ultimate authority. If you discover a disparity, please let us know at [firstroboticscompetition@firstinspires.org](mailto:firstroboticscompetition@firstinspires.org) and we will correct it.

Team resources that aren’t generally season specific (e.g., what to expect at an event, communication resources, team organization recommendations, ROBOT transportation procedures, and award descriptions) can be found on the [FIRST Robotics Competition website](#).

---

## 1.8 Translations & Other Versions

---

The CHARGED UP manual is originally and officially written in English and is occasionally translated into other languages for the benefit of *FIRST* Robotics Competition teams whose native language may not be English.

A text-based English version can be provided only for use with assistive devices and not for redistribution. For more information, please contact the *FIRST* Robotics Competition Team Experience Specialist at [frcteamadvocate@firstinspires.org](mailto:frcteamadvocate@firstinspires.org).

In the event that a rule or description is modified in an alternate version of this manual, the English pdf version as published on the [CHARGED UP - Season Materials web page](#) is the commanding version.

---

## 1.9 Team Updates

---

Team Updates are used to notify the *FIRST* Robotics Competition community of revisions to the official season documentation (e.g. the manual, drawings, etc.) or important season news. Team Update posts are scheduled as follows:

- each Tuesday and Friday, starting on the first Tuesday after Kickoff and ending on the Tuesday prior to Week 1 events
- each Tuesday, starting Week 1 and ending the week of the final District Championship events.

Team Updates are posted on the [CHARGED UP - Season Materials web page](#) and are generally posted before 5 pm, Eastern.

Generally, Team Updates follow the following convention:

- Additions are highlighted in yellow. **This is an example.**
- Deletions are indicated with a strikethrough. ~~This is an example.~~

---

## 1.10 Question and Answer System

---

The [Question and Answer System](#) (Q&A) is a resource for clarifying the [2023 CHARGED UP Game Manual](#), [Awards webpages](#), [official FIELD drawings](#), and/or [FIRST Robotics Competition District and Regional Events web page](#) content. Teams can search for previously asked questions and responses or pose new questions. Questions can include examples for clarity or reference multiple rules to understand the relationships and differences between them.

The Q&A opens on January 11, 2023, 12:00 PM Eastern. Details on the Q&A can be found on the [CHARGED UP - Season Materials web page](#). The Q&A may result in revisions to the text in the official manuals (which are communicated using the process described in Team Updates).

The responses in the Q&A do not supersede the text in the manual, although every effort will be made to eliminate inconsistencies between the two. While responses provided in the Q&A may be used to aid discussion at each event, per Inspection & Eligibility Rules and REFEREE Interaction, REFEREES and INSPECTORS are the ultimate authority on rules. If you have concerns about enforcement trends by volunteer authorities, please notify *FIRST* at [firstroboticscompetition@firstinspires.org](mailto:firstroboticscompetition@firstinspires.org).

The Q&A is not a resource for firm predictions on how a situation will play out an event. Questions about the following will not be addressed:



- 
- rulings on vague situations,
  - challenging decisions made at past events, or
  - design reviews of a ROBOT system for legality.

Weak questions are overly broad, vague, and/or include no rule references. Some examples of questions that will not be answered in the Q&A are:

- Is this part/design legal?
- How should the REFEREE have ruled when this specific game play happened?
- Duplicate questions
- Nonsense questions

Good questions ask generically about features of parts or designs, gameplay scenarios, or rules, and often reference one or more relevant rules within the question. Some examples of questions that will likely be answered in the Q&A are:

- A device we are considering using on the ROBOT comes with purple AWG 40 wire, does this comply with R?? and R??
- We're not sure how to interpret how Rule G?? applies if blue ROBOT A does X and red ROBOT B does Y, can you please clarify?
- If a ROBOT does this specific action, is it doing what this defined term is describing?

Questions from "FRC 0" represent content asked by key volunteers (e.g., REFEREES, INSPECTORS, etc.), answered by *FIRST*, and are considered relevant to teams.



## 2 FIRST SEASON OVERVIEW

# FIRST<sup>®</sup>

# ENERGIZE<sup>SM</sup>

PRESENTED BY **Qualcomm**

This is the moment to get energized to innovate. From the machines that move us to the food that sustains us to the wireless technologies that connect us, energy plays an essential role in keeping our world running. During our 2022-2023 robotics season, **FIRST® ENERGIZE<sup>SM</sup>** presented by Qualcomm, our teams will reimagine the future of sustainable energy and power their ideas forward. Innovation can't wait.

This year, **FIRST** teams will address today's global challenges related to [United Nations Sustainable Development Goal #7](#), focused on ensuring access to affordable, reliable, sustainable, and modern energy for all. By encouraging **FIRST** participants to think about future energy sustainability, we're also empowering them to be the next generation of leaders and innovators, tackling the world's toughest challenges.





PRESENTED BY   
Gene Haas Foundation

The Gene Haas Foundation is proud to be the presenting sponsor of the 2023 *FIRST*<sup>®</sup> Robotics Competition season.

**The Gene Haas Foundation sees the growing need for skilled manufacturing employees industry wide. By expanding access to high-quality manufacturing technology training programs and supporting organizations like *FIRST*<sup>®</sup>, the Gene Haas Foundation is energizing the future of STEM.**

**The skills you develop in *FIRST* Robotics Competition are relevant, in demand, and the same skills needed for the future.**

**How will you power new ideas forward?**

**Good luck to all the teams this season!**

## 4 GAME OVERVIEW

Figure 4-1 CHARGED UP field and key elements

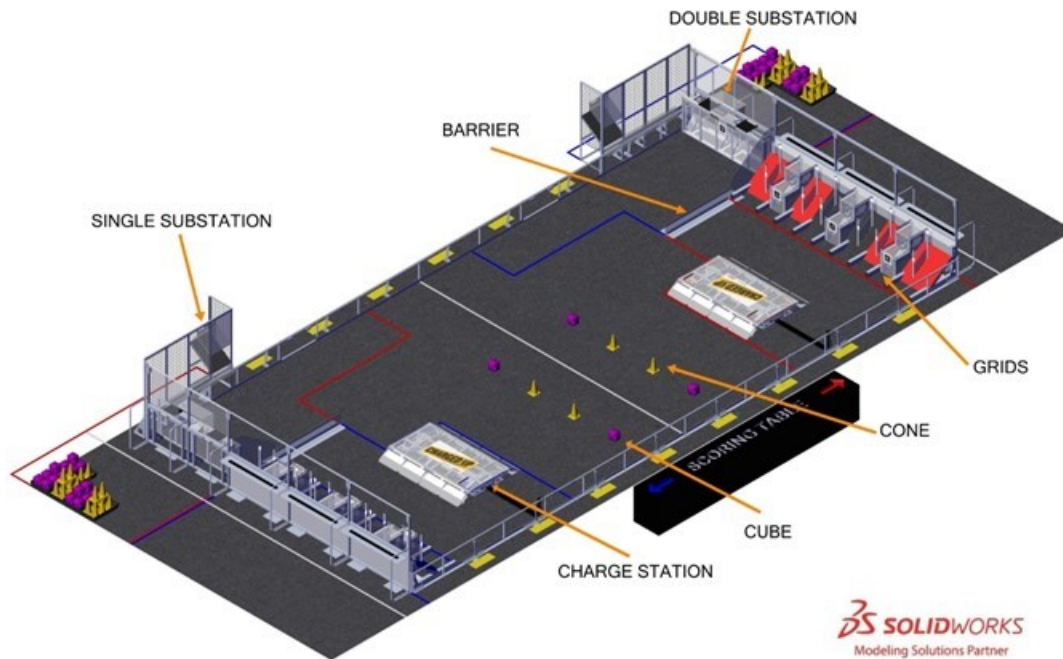

In CHARGED UP<sup>SM</sup> presented by Haas, two competing alliances are invited to process game pieces to bring energy to their community. Each alliance brings energy to their community by retrieving their game pieces from substations and scoring it into the grid. Human players provide the game pieces to the robots from the substations. In the final moments of each match, alliance robots race to dock or engage with their charge station!

Each match begins with a 15-second autonomous period, during which time alliance robots operate only on pre-programmed instructions to score points by:

- leaving their community,
- retrieving and scoring game pieces onto the grid,
- docking on or engaging with their charge station.

In the final 2 minutes and 15 seconds of the match, drivers take control of the robots and score points by:

- continuing to retrieve and score their game pieces onto the grid and
- docking on or engaging with their charge station.

The alliance with the highest score at the end of the match wins!



## 5 ARENA

The ARENA includes all elements of the game infrastructure that are required to play CHARGED UP<sup>SM</sup> presented by Haas: the FIELD, GAME PIECES, and all equipment needed for FIELD control, ROBOT control, and scorekeeping.

The ARENA is modular and assembled, used, disassembled, and shipped many times during the competition season. It will undergo wear and tear. The ARENA is designed to withstand rigorous play and frequent shipping. Every effort is made to ensure that ARENAS are consistent from event to event. However, ARENAS are assembled in different venues by different event staff and some small variations occur. For details regarding assembly tolerances, please refer to the [2023 ARENA Layout and Marking Diagram](#). Successful teams will design ROBOTS that are insensitive to these variations.

Illustrations included in this section are for a general visual understanding of the CHARGED UP ARENA, and dimensions included in the manual are nominal. Please refer to the official drawings for exact dimensions, tolerances, and construction details. The official drawings, CAD models, and drawings for low-cost versions of important elements of the CHARGED UP FIELD are posted on the [CHARGED UP - Playing FIELD web page](#) on the FIRST website.

### 5.1 FIELD

Figure 5-1: CHARGED UP

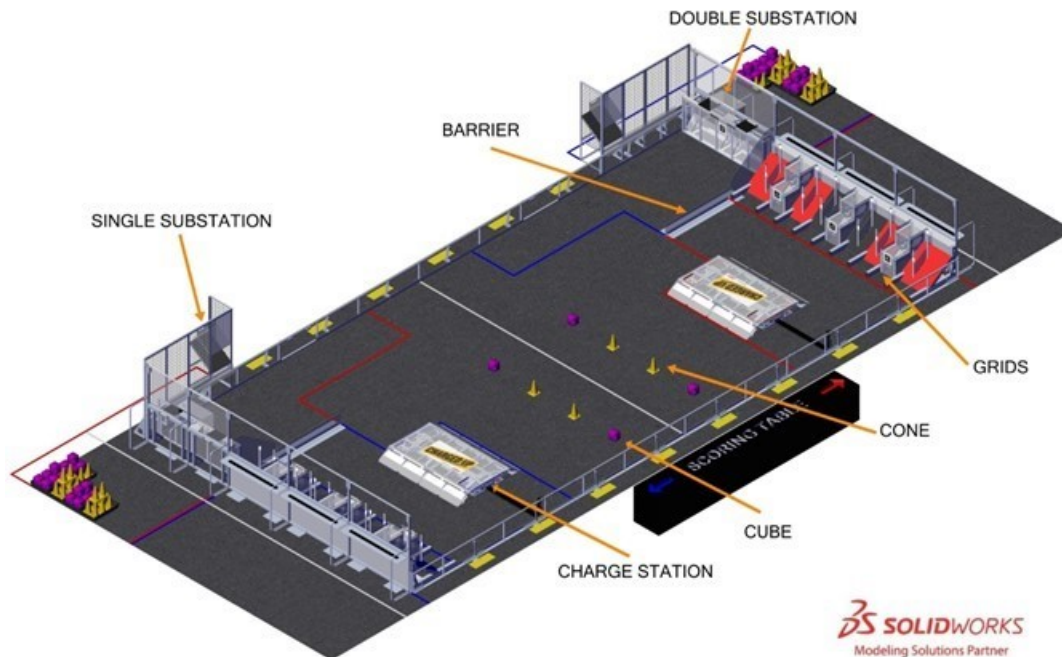

Each FIELD for CHARGED UP is an approximately 26 ft. 3½ in. (~802 cm) by 54 ft. 3¼ in. (~1654 cm) carpeted area bound by and including the inward- and upward-facing surfaces of the guardrails, inward-facing surfaces of the ALLIANCE WALLS, inward-facing surfaces of the SINGLE SUBSTATION (excluding the PORTALS), and the outermost vertical and diagonal polycarbonate surfaces of the DOUBLE SUBSTATION (excluding the PORTALS).



Figure 5-2 CHARGED UP FIELD boundary

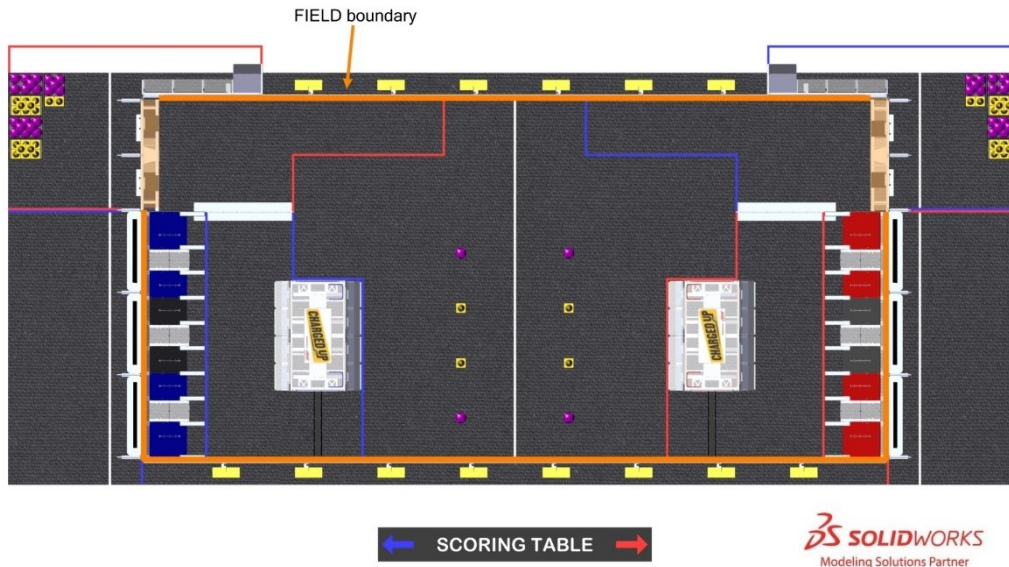
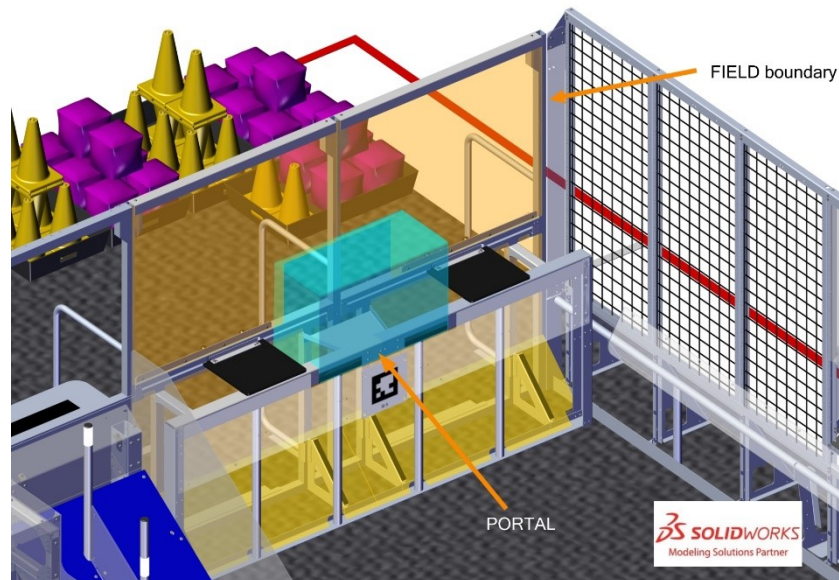

Figure 5-3 CHARGED UP FIELD boundary at DOUBLE SUBSTATION



The FIELD is populated with the following elements:

- 3 red GRIDS and 3 blue GRIDS located in front of their corresponding ALLIANCE WALLS,
- 1 red CHARGE STATION and 1 blue CHARGE STATION located in their corresponding COMMUNITIES,
- 1 red SINGLE SUBSTATION and 1 Blue SINGLE SUBSTATION located along the guardrail in their corresponding SUBSTATION AREA,
- 1 red DOUBLE SUBSTATION and 1 blue DOUBLE SUBSTATION each located in line with and adjacent to the opposing ALLIANCE WALL
- 2 BARRIERS, 1 separating each COMMUNITY from the opposing ALLIANCE'S LOADING ZONE.

The surface of the FIELD is low pile carpet, Shaw Floors, Philadelphia Commercial, Neyland II 20, “66561 Medallion” (please note that Neyland II carpet is not available for team purchase and the closest equivalent is [Neyland III](#)). The edge of the carpet is secured to the venue floor using [3M™ Premium Matte Cloth \(Gaffers\) Tape GT2](#) or comparable gaffers tape.

Guardrails form the long edges of the FIELD. Guardrails are a 1 ft. 8 in. (~51 cm) tall system of transparent polycarbonate supported on the top and bottom by aluminum extrusion. There are 4 gates in the guardrail that allow access to the FIELD for placement and removal of ROBOTS. The gate passthrough, when open, is 3 ft. 2 in. (~97 cm) wide. Gates are closed and shielded during the MATCH.

Figure 5-4 Gate locations

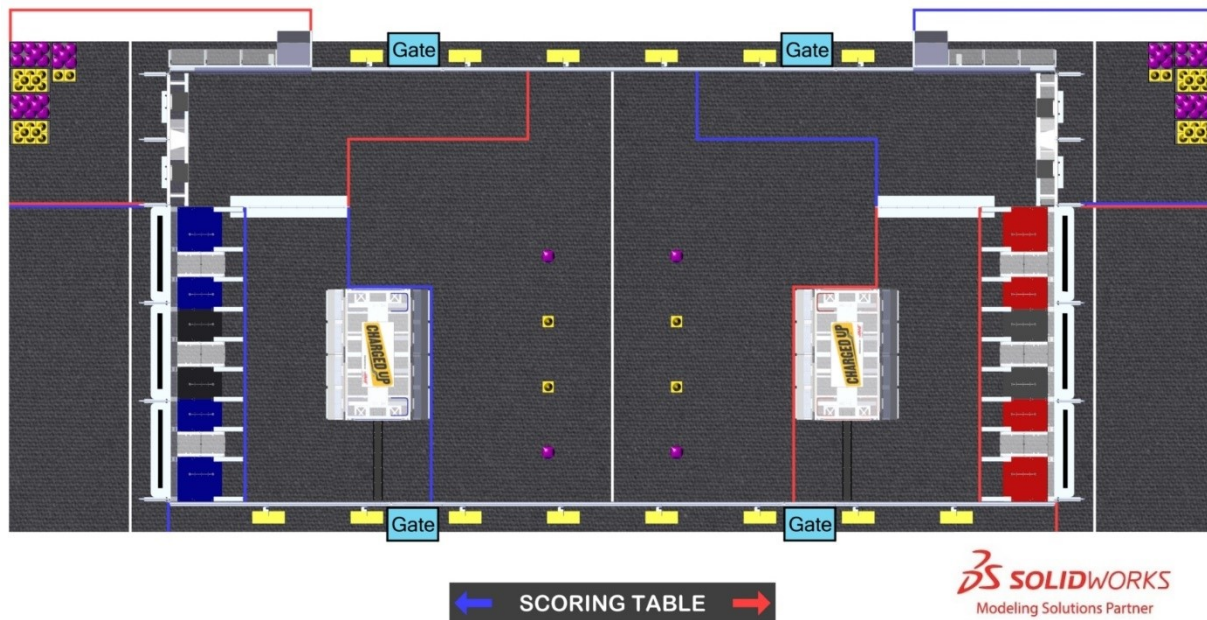

There are 2 versions of guardrails and DRIVER STATIONS used for competitions. 1 design is reflected in the [2023 Official FIRST Field Drawings & Models](#). The other is designed and sold by AndyMark. While the designs are slightly different, the critical dimensions, performance, and expected user experience between them are the same unless otherwise noted. Detailed drawings for the AndyMark design are posted on the [AndyMark website](#). All illustrations in this manual show the traditional FIELD design.

Runs of black HDPE cable protectors extend from the guardrail on the scoring table side of the FIELD to the center of each CHARGE STATION. A cable protector run is made up of multiple floor segments and an exit segment. The total length of the cable protector run is 5 ft. 6 in. (~168 cm). The floor segments are  $\frac{3}{4}$  in. (~19 mm) tall, 7 in. (~18 cm) wide, with  $\sim 45^\circ$  lead in ramps on each leading edge and secured to the carpet using hook fastener which increases the height to approximately  $\frac{7}{8}$  in. (~22 mm). Exit segments mount over the guardrail and are 1 ft.  $8\frac{3}{4}$  in. (~53 cm) tall, 6 in. (~15 cm) wide and extend into the field  $1\frac{3}{4}$  in. (~4 cm).

Figure 5-5 Cable protector segment

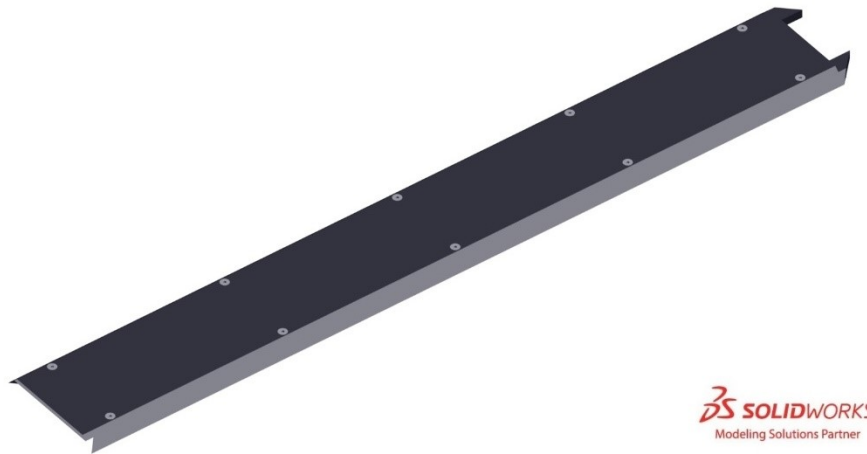

**SOLIDWORKS**  
Modeling Solutions Partner

## 5.2 Areas, Zones, and Markings

FIELD areas, zones, and markings of consequence are described below. Unless otherwise specified, the tape used to mark lines and zones throughout the FIELD is 2-in. (~5 cm) [3M™ Premium Matte Cloth \(Gaffers\) Tape \(GT2\)](#) or comparable gaffers tape.

Figure 5-6 Areas, Zones, and Markings

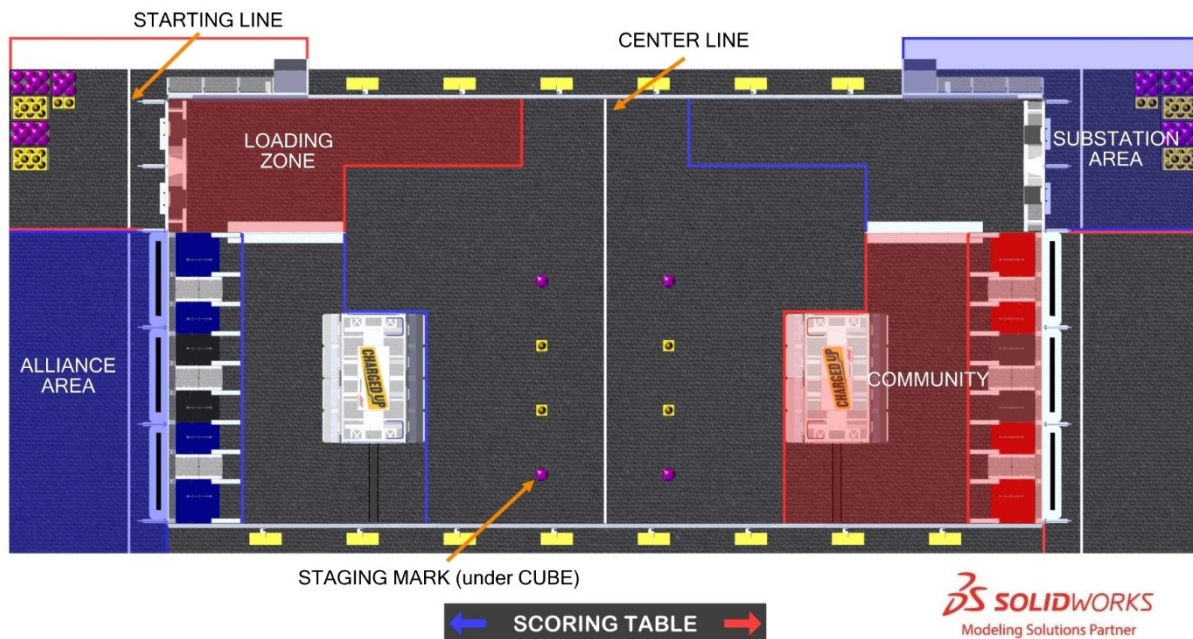

**SOLIDWORKS**  
Modeling Solutions Partner

- ALLIANCE AREA: a 20 ft. (~609 cm) wide by 9 ft. 10¼ in. (~300 cm) deep infinitely tall volume formed by, and including the ALLIANCE WALL, the edge of the carpet, and ALLIANCE colored tape.
- CENTER LINE: a white tape line that bisects the length of the FIELD.



- **COMMUNITY:** an 18 ft. (~549 cm) wide by 11 ft.  $\frac{3}{8}$  in. (~336 cm) to 16 ft.  $1\frac{1}{4}$  in. (~491 cm) deep infinitely tall volume formed by the ALLIANCE WALL, the plane defined by the BARRIER plastic, ALLIANCE colored tape, and the guardrail. The COMMUNITY includes the tape.
- **LOADING ZONE:** an 8 ft. 3 in. (~252 cm) wide by 11 ft.  $\frac{1}{4}$  in. (~336 cm) to 22 ft.  $\frac{1}{4}$  in. (~671 cm) deep infinitely tall volume formed by the DOUBLE SUBSTATION, the plane defined by the BARRIER plastic, the guardrail, and ALLIANCE colored tape. The LOADING ZONE includes the tape.
- **STAGING MARK:** 1 of 8 marks used to identify starting locations for GAME PIECES. Marks are 4 in. (~10 cm) by 4 in. (~10 cm) crosses made from black tape. Marks are spaced 4 ft. (~122 cm) apart from each other. Each set of 4 marks is centered about the width of the COMMUNITY and is located 18 ft. 8 in. (~569 cm) from the far edge of the corresponding GRID tape as shown in Figure 5-7.

Figure 5-7 STAGING MARK locations

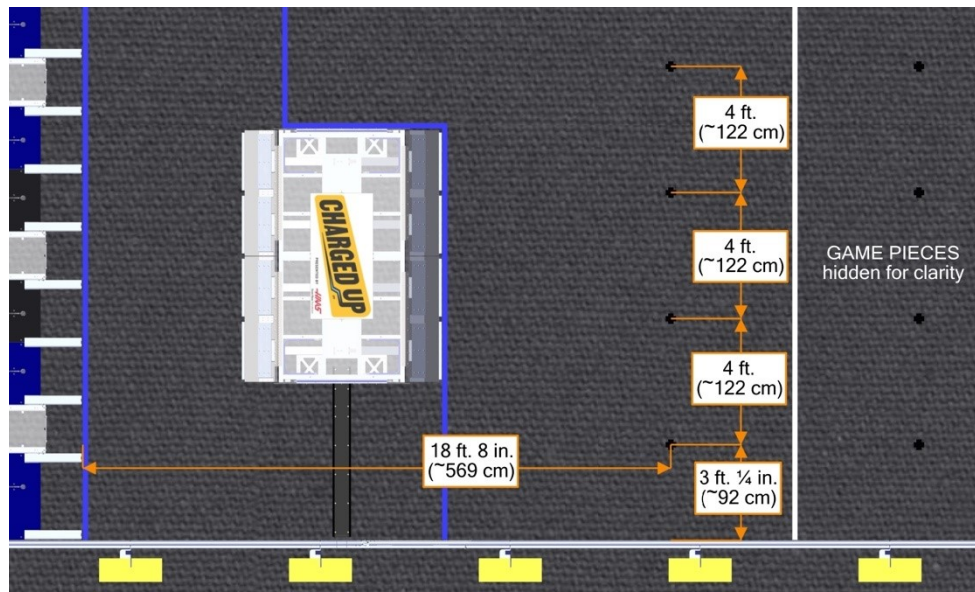

**SOLIDWORKS**  
Modeling Solutions Partner

- **STARTING LINE:** a white tape line spanning the ALLIANCE AREA and SUBSTATION AREA located 2 ft. 4 in. (~71 cm) from the face of the ALLIANCE WALL to the near edge of the tape.
- **SUBSTATION AREA:** a 12 ft. (~366 cm) wide by 18 ft. 7 in. (~566 cm) deep infinitely tall volume formed by and including the DOUBLE SUBSTATION, the edge of the carpet, the guardrail, the SINGLE SUBSTATION and ALLIANCE colored tape. The SUBSTATION AREA includes the PORTALS and the tape.

### 5.3 BARRIER

Figure 5-8: BARRIER

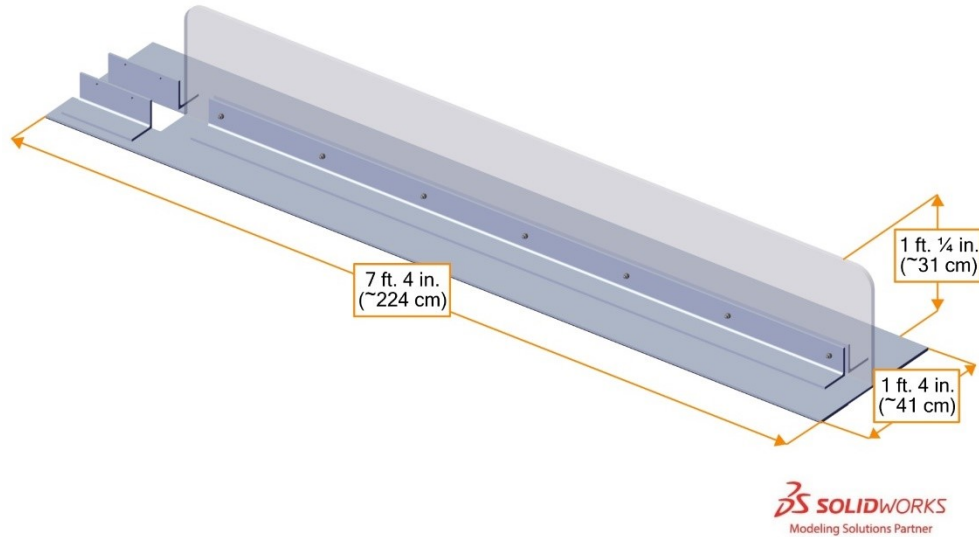

A BARRIER is a 7 ft. 4 in. (~224 cm) long assembly that separates each COMMUNITY from its adjacent LOADING ZONE. The BARRIER has a base that is 1 ft. 4 in. (~41 cm) wide and 1/4 in. (~6 mm) tall. The base supports a 1/2 in. (~13 mm) thick, 1 ft. 1/4 in. (~31 cm) tall polycarbonate wall.

### 5.4 CHARGE STATION

Figure 5-9 LEVEL CHARGE STATION (click image to see field tour video)

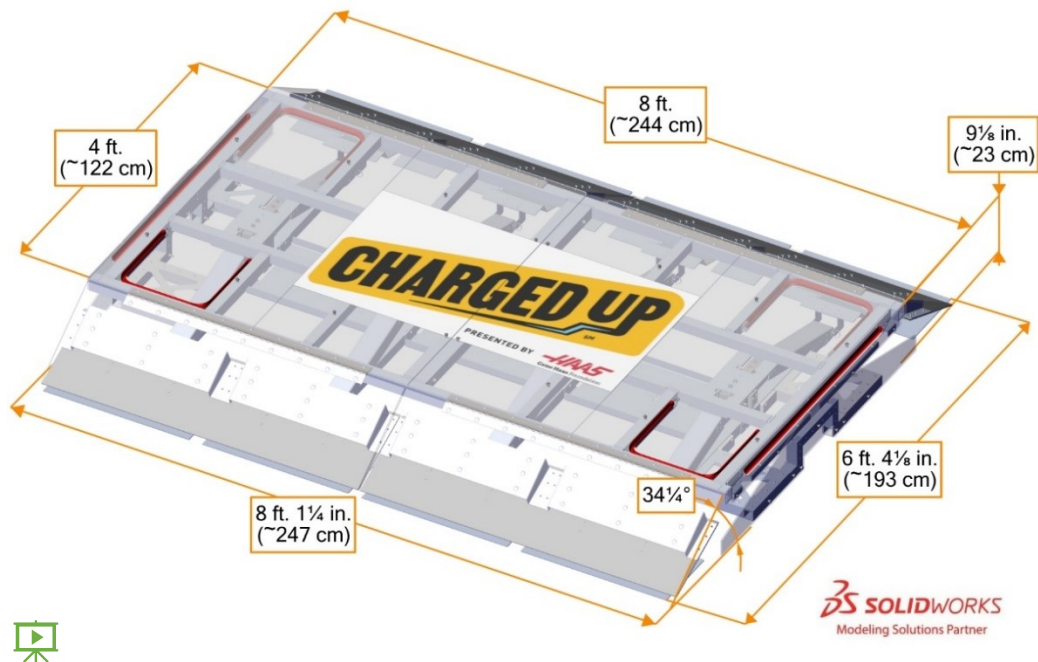

A CHARGE STATION is an 8 ft. 1¼ in. (~247 cm) wide, 6 ft. 4⅞ in. (~193 cm) deep structure that is located in each COMMUNITY such that its center is 8 ft. 2⅝ in. (~251 cm) from the far edge of the GRID'S tape line and centered in the width of the COMMUNITY. Each CHARGE STATION consists of the main pivoting frame, lead-in ramps, and the support structure. The main pivoting frame is mounted to the base frame via a set of 4 double hinges.

The main pivoting surface of a CHARGE STATION is 8 ft. (~244 cm) wide and 4 ft. (~122 cm) deep. It pivots +/- 15° about its long axis. When parallel to FIELD carpet, the top polycarbonate surface is 9⅞ in. (~23 cm) above FIELD carpet as shown in Figure 5-9. When pivoted to 15°, the highest edge is 1 ft. 4 in. (~41 cm) above FIELD carpet. In normal operation, a CHARGE STATION will naturally return to the middle of the LEVEL range. A CHARGE STATION is considered LEVEL if it is within approximately 2½° of parallel to FIELD carpet.

Polycarbonate ramps are located on the long edges of each CHARGE STATION. The ramps are 1 ft. 3⅞ in. (~39 cm) long and span the full width of the CHARGE STATION. The ramps pivot and slide as the main pivoting surface moves. When the CHARGE STATION top is LEVEL, the ramps are tilted at an angle of approximately 34¼° as shown in Figure 5-9. When the CHARGE STATION is fully tilted, the lower ramps are at an angle of approximately 11° and the upper ramps are at an angle of approximately 71½°, as shown in Figure 5-10.

Figure 5-10 Fully tilted CHARGE STATION

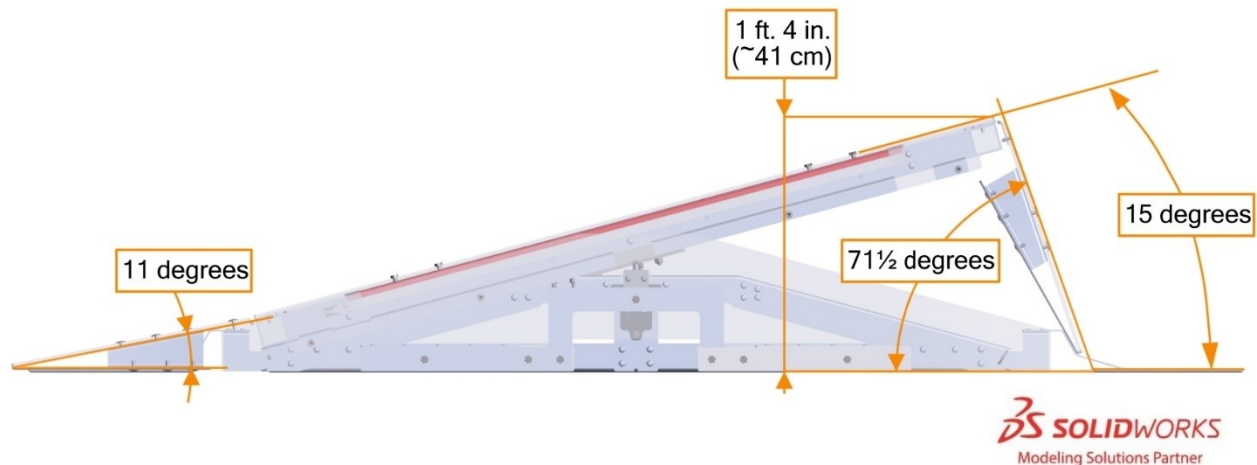

The short edges of the CHARGE STATION feature guards that restrict access to the underside of the structure.

### 5.4.1 CHARGE STATION lighting

Figure 5-11 CHARGE STATION LEVEL lighting example

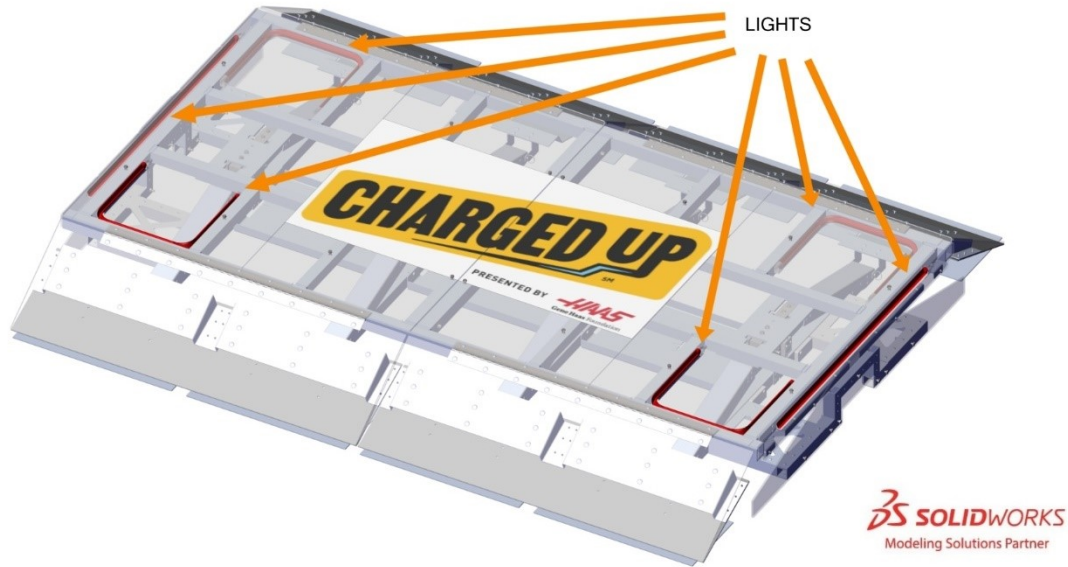

ALLIANCE colored lights located along the short edges of the CHARGE STATION and at the 4 corners of the top surface indicate if it is LEVEL.

Table 5-1 ENGAGED light states

Light State	Criteria
Off	Outside of a MATCH In MATCH: CHARGE STATION is not LEVEL
ALLIANCE color	CHARGE STATION is LEVEL



## 5.5 GRIDS

Figure 5-12 BLUE ALLIANCE GRIDS (click image to see field tour video)

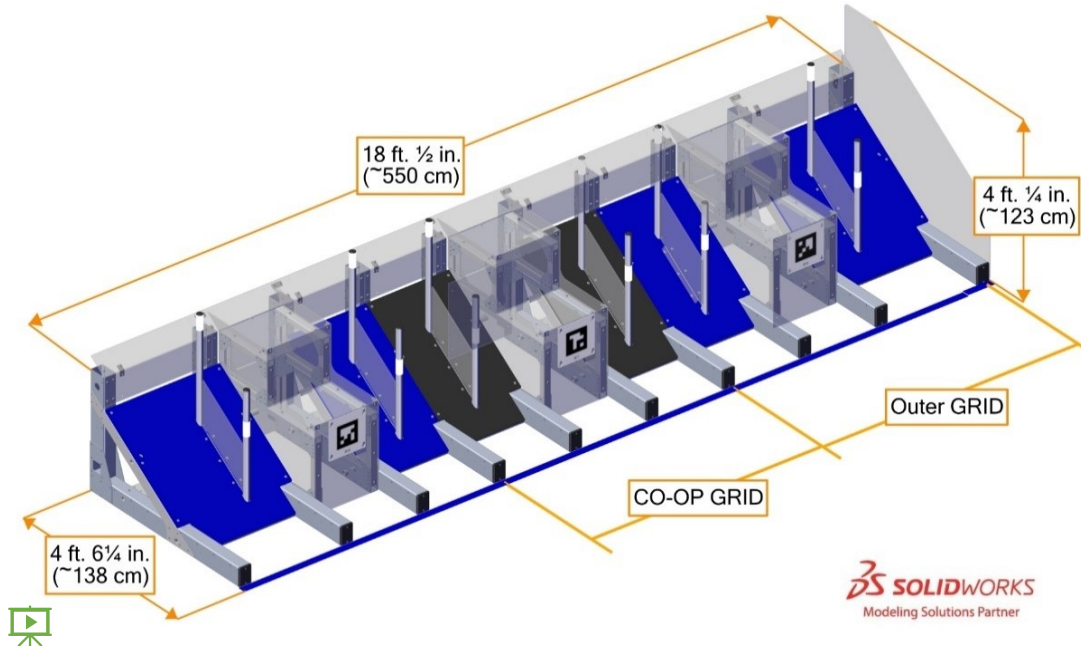

A collection of 3 GRIDS consisting of 2 outer GRIDS and a *Coopertition* (CO-OP) GRID is located in front of each ALLIANCE WALL adjacent to the guardrail and BARRIER. The full structure is an 18 ft. ½ in. (~550 cm) wide, 4 ft. ¼ in. (~123 cm) tall, 4 ft. 6¼ in. (~138 cm) deep assembly. A strip of ALLIANCE-colored tape is included in the GRIDS and defines its front plane.

Figure 5-13 Individual GRID overall sizing

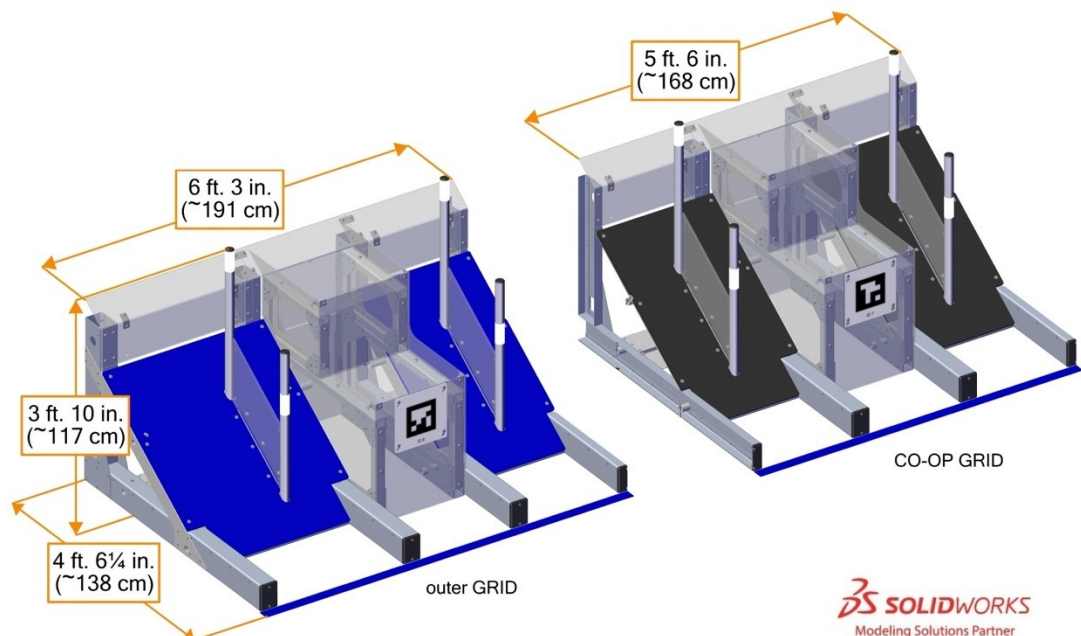

A GRID is a 3 ft. 10 in. (~117 cm) tall, 4 ft. 6¼ in. (~138 cm) deep assembly that includes the ALLIANCE colored tape line. Outer GRIDS are 6 ft. 3 in. (~191 cm) wide. The CO-OP GRID is 5 ft. 6 in. (~168 cm) wide.

Each GRID contains 9 GAME PIECE scoring locations called NODES:

- 3 HYBRID NODES
- 2 CUBE NODES, and
- 4 CONE NODES.

Each set of GRIDS is divided into 3 ROWS. A ROW is a series of 9 horizontally adjacent NODES where GAME PIECES can be scored for a common number of points. The bottom ROW consists of 9 HYBRID NODES. The middle ROW and top ROW each consist of 6 CONE NODES and 3 CUBE NODES.

Figure 5-14 GRID NODES and ROWS

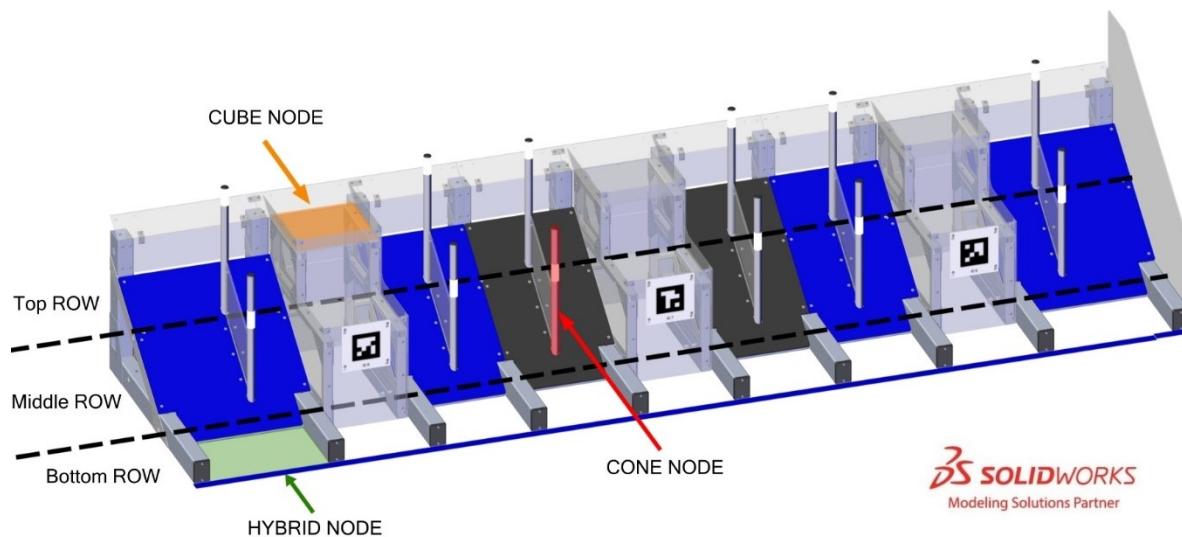

A HYBRID NODE is a 1 ft. 4 in. (~41 cm) deep carpeted surface contained within the GRID. The 2 outermost HYBRID NODES in each collection of GRIDS are 2 ft. 1¼ in. (~65 cm) wide and the rest of the HYBRID NODES are 1 ft. 6½ in. (~47 cm) wide. HYBRID NODES have 5 in. (~13 cm) tall dividers between them. A guardrail or BARRIER runs coincident to the left and right outermost edges of a collection of GRIDS which limits access to outermost NODES.

Each CUBE NODE is a polycarbonate shelf that is 1 ft. 6¼ in. (~46 cm) wide and 1 ft. 5 in. (~43 cm) deep. CUBE NODES are surrounded by 3 in. (~5 cm) tall vertical walls, with the exception of the rear wall of the top ROW CUBE NODE which is angled. The distance from the FIELD carpet to the top of a middle ROW CUBE NODE wall is 1 ft. 11½ in. (~60 cm). The distance from the FIELD carpet to the top of a top ROW CUBE NODE wall is 2 ft. 11½ in. (~90 cm). The front of a middle ROW CUBE NODE is 1 ft. 2¼ in. (~36 cm) from the front face of the GRID. The front of a top ROW CUBE NODE is 2 ft. 7⅞ in. (~80 cm) from the front face of the GRID.

Each CONE NODE is a 1¼ in. Schedule 40 (1.66 in. (~4 cm) outer diameter) aluminum pipe with a plug installed in the top ([Caplugs part number CCF-RT-13-1](#)). CONE NODES are perpendicular to FIELD carpet. The top of a CONE NODE in the middle ROW is 2 ft. 10 in. (~87 cm) above FIELD CARPET. The top of a CONE NODE in the top ROW is 3 ft. 10 in. (~117 cm) above FIELD carpet. The center of a middle ROW CONE NODE is 1 ft. 10¾ in. (~58 cm) from the front face of the GRID. The center of a top ROW CONE NODE is 3 ft. 3¾ in. (~101 cm) from the front face of the GRID. A polycarbonate fin runs between each

middle ROW CONE NODE and its adjacent top ROW CONE NODE. The textured plastic surface beneath the CONE NODES is angled ~35° from FIELD carpet.

Figure 5-15 GRID top view dimensions

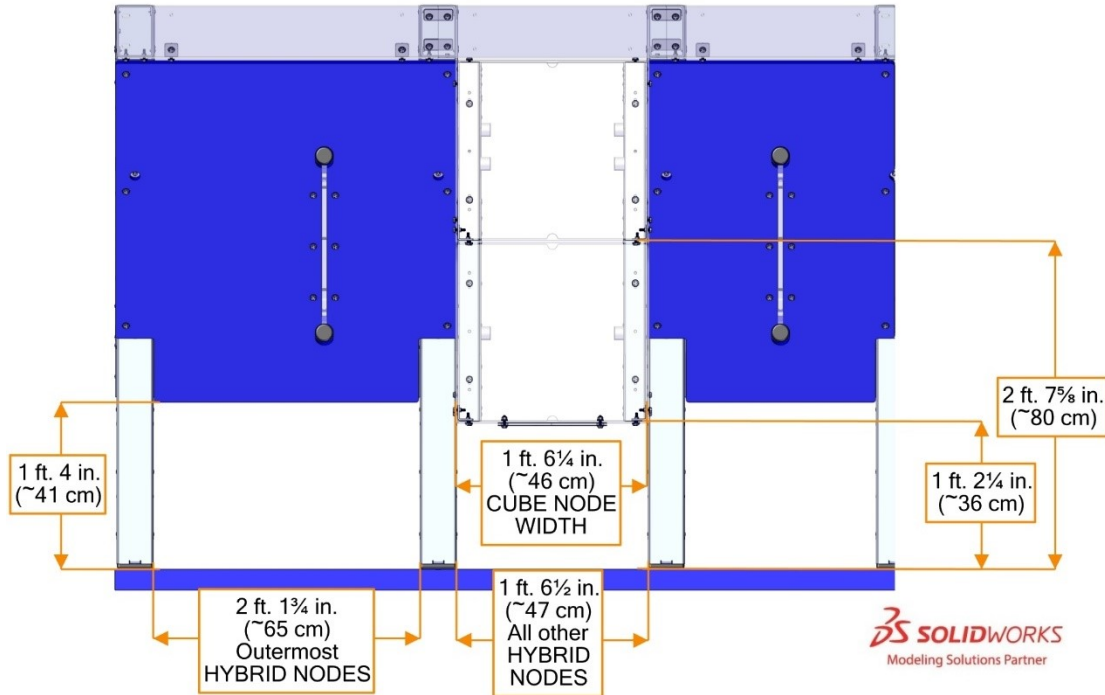
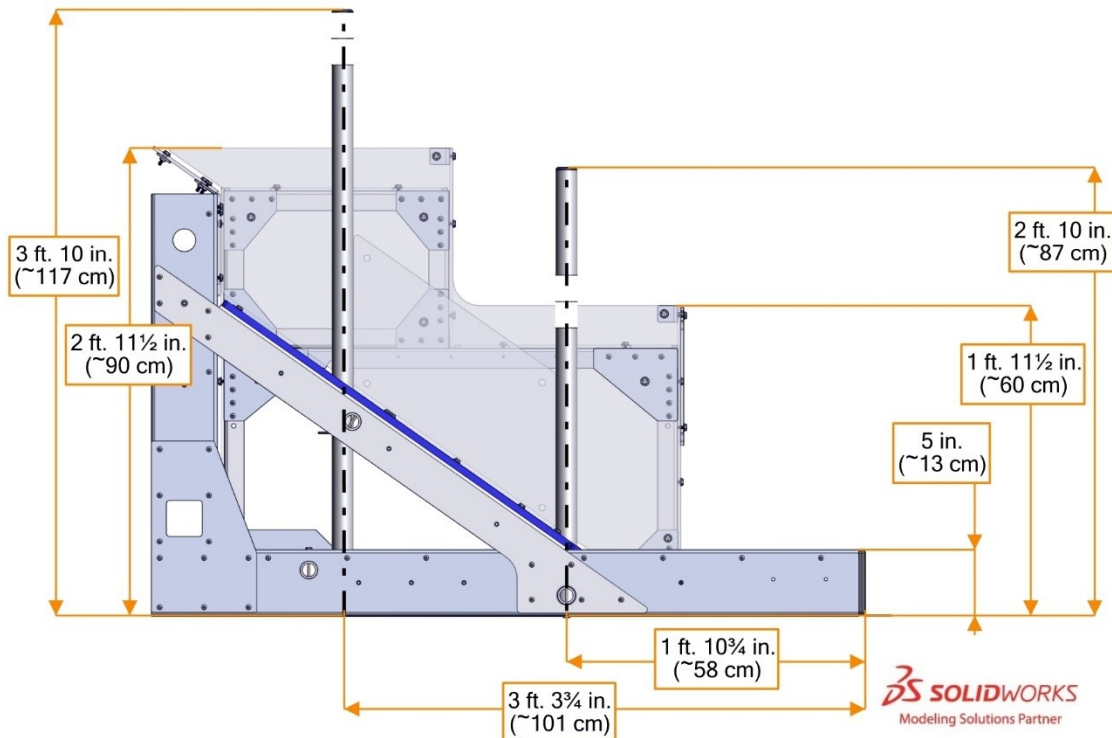

Figure 5-16 GRID side view dimensions



## 5.6 SUBSTATIONS

A SUBSTATION is an assembly used to move GAME PIECES from humans to ROBOTS or onto the FIELD. There are 2 types of SUBSTATIONS in each SUBSTATION AREA: a SINGLE SUBSTATION and a DOUBLE SUBSTATION.

Each SUBSTATION contains a PORTAL - a three-dimensional volume through which humans transfer GAME PIECES to ROBOTS or the FIELD.

We recognize that some individuals may need an accommodation in order to use the SUBSTATIONS, please see the language at the start of [Section 8 Game Rules: Humans](#) information.

Each ALLIANCE'S DOUBLE SUBSTATION is attached to and in-line with their opponent's ALLIANCE WALL. Each SINGLE SUBSTATION is in-line with the guardrail.

Figure 5-17 SUBSTATIONS (click image to see field tour video)

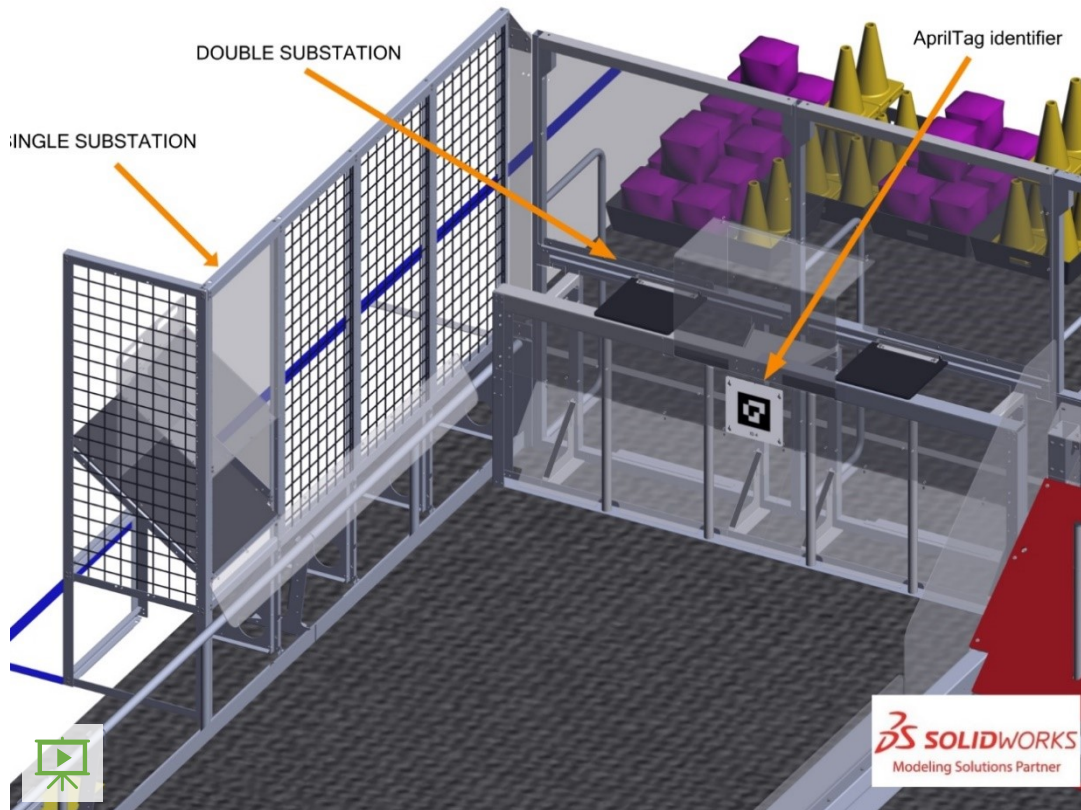



## 5.6.1 SINGLE SUBSTATION

Figure 5-18 SINGLE SUBSTATION

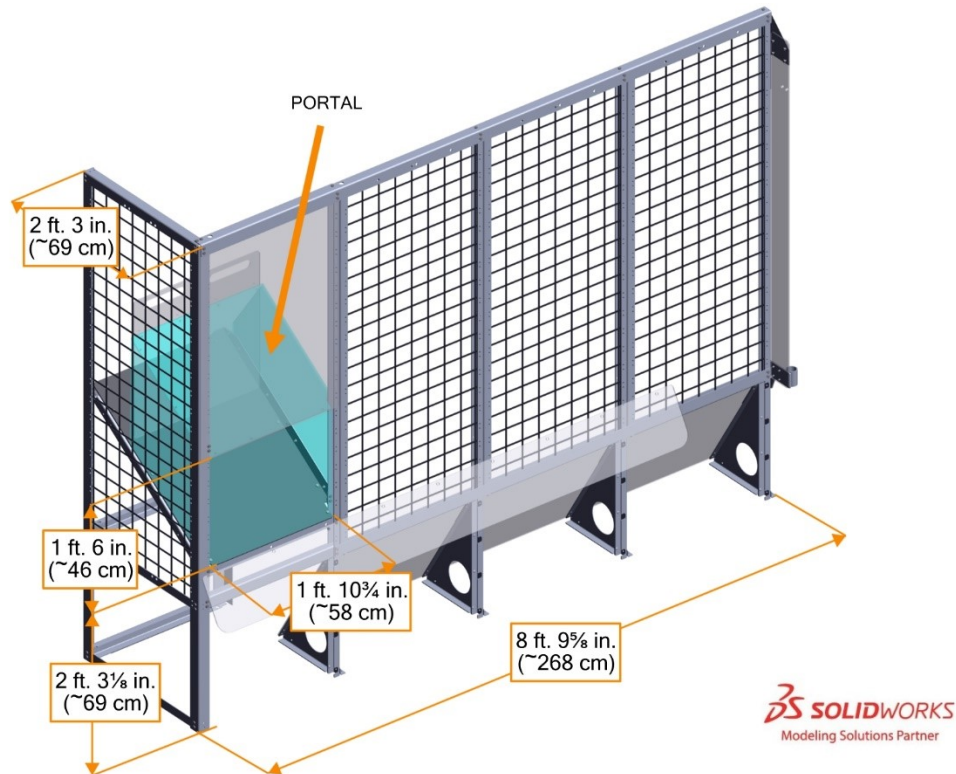

A SINGLE SUBSTATION is 8 ft. 9 5/8 in. (~268 cm) wide, 6 ft. 9 3/8 in. (~208 cm) tall, and 2 ft. 3 in. (~69 cm) deep. The FIELD-facing wall of the SINGLE SUBSTATION sits 3 1/8 in. (~8 cm) behind the guardrail on a traditional FIELD and 4 1/4 in. (~11 cm) behind the guardrail on an AndyMark field. Each SINGLE SUBSTATION is comprised of wire panels ([Uline H-6277BL](#)), an attachment point to the FIELD, and a chute assembly. The chute assembly is a tilted plastic enclosure in which GAME PIECES enter the FIELD through a PORTAL. The FIELD-side opening of the chute is 2 ft. 3 1/8 in. (~69 cm) off the ground, 1 ft. 6 in. (~46 cm) tall, and 1 ft. 10 3/4 in. (~58 cm) wide. Each SINGLE SUBSTATION includes a flap that retains GAME PIECES until opened by a HUMAN PLAYER. The PORTAL for the SINGLE SUBSTATION is defined by the flap, the front face of the SINGLE SUBSTATION, and the sides, top, and bottom plastic of the chute.

## 5.6.2 DOUBLE SUBSTATION

Figure 5-19 DOUBLE SUBSTATION

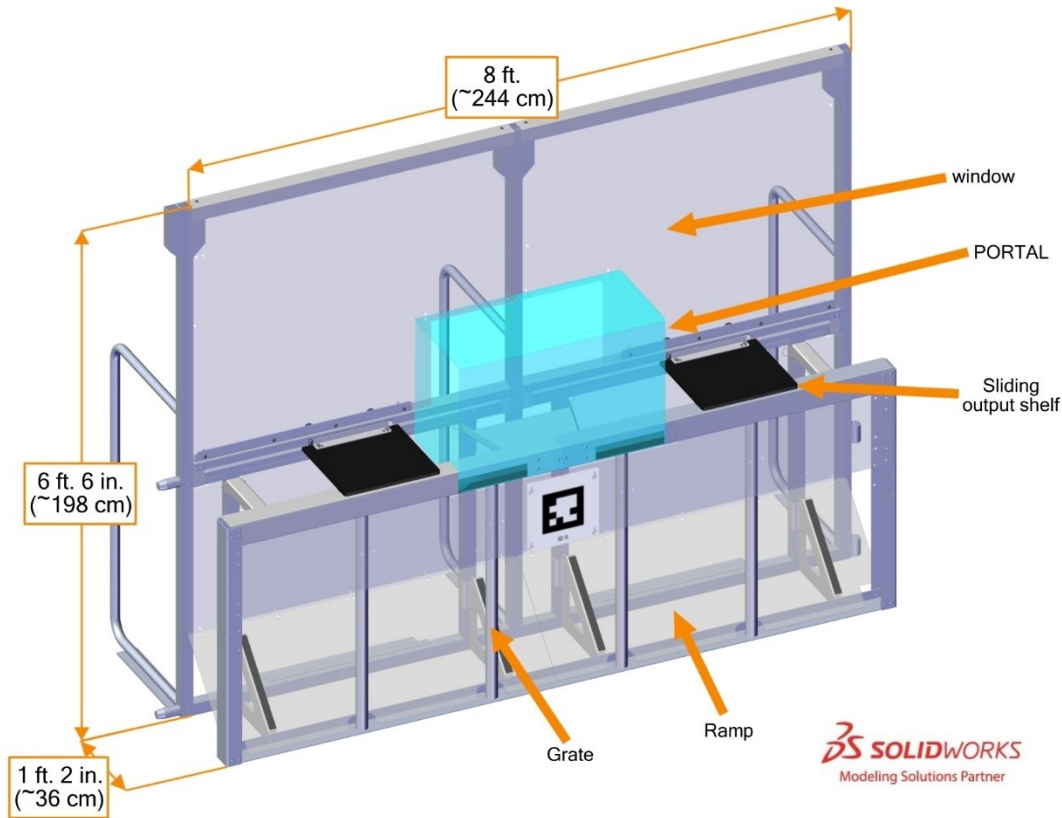

A DOUBLE SUBSTATION is a 6 ft. 6 in. (~198 cm) tall, 8 ft. (~244 cm) wide assembly that extends 1 ft. 2 in. (~36 cm) into the FIELD. Each DOUBLE SUBSTATION contains a grate with 5 openings, a ramp, a PORTAL, and 2 sliding output shelves.

Grate openings are defined by 1¼ in. schedule 40 aluminum pipes which have an outer diameter of 1.66 in. (~4 cm). The distance between pipes is 1 ft. 3 in. (~38 cm). A polycarbonate ramp spans the width of the DOUBLE SUBSTATION, is sloped at a 45-degree angle, and extends from the grate to the back of the DOUBLE SUBSTATION.

The DOUBLE SUBSTATION PORTAL is the volume contained between the window and the bent polycarbonate guard, as shown in Figure 5-19.

Sliding shelves made of ½ in. (~13 mm) thick textured HDPE may be used to move GAME PIECES out of the PORTAL and make them accessible to ROBOTS. Shelves are controlled by HUMAN PLAYERS using handles. The shelves are 1 ft. 2 in. (~36 cm) wide, 1 ft. 1 in. deep (~33 cm) and their top surface is 3 ft. 1⅜ in. (~95 cm) above the carpet. Each shelf can slide from the PORTAL to an edge of the DOUBLE SUBSTATION.

Figure 5-20 Dimensions for DOUBLE SUBSTATION

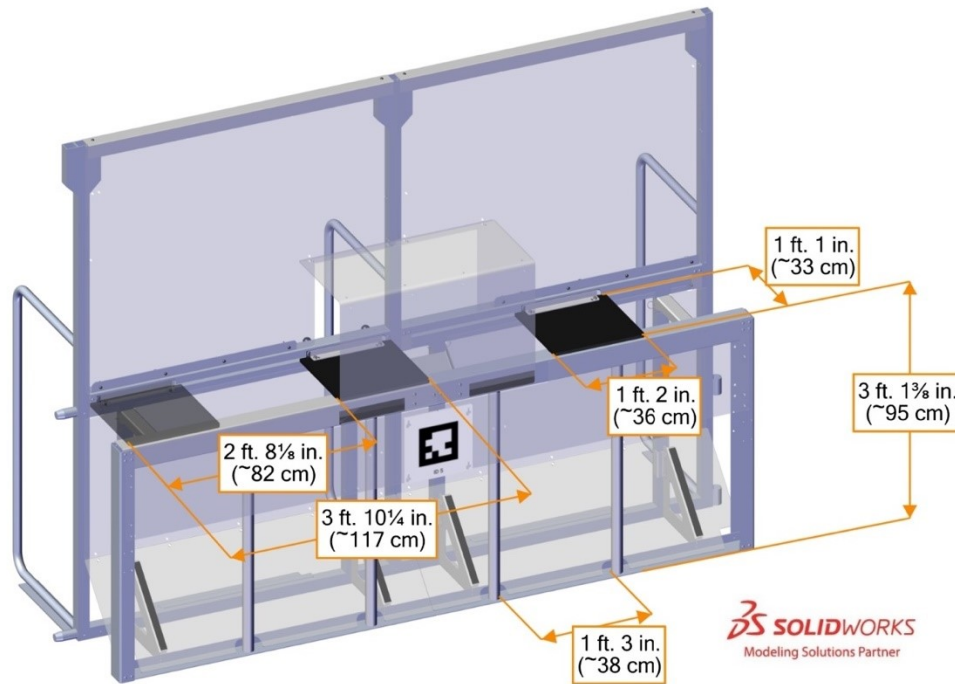

Each DOUBLE SUBSTATION is located between the guardrail and a GRID. The distance from the edge of the PORTAL to the GRID is 2 ft. 10 1/4 in. +/- 1 in. (~87 cm +/- 25 mm). The distance from the edge of the PORTAL to the guardrail is 2 ft. 10 1/8 in. (~89 cm) on a traditional FIELD, or 2 ft. 10 in. (~87 cm) on an AndyMark FIELD, as shown in Figure 5-21.

Figure 5-21 DOUBLE SUBSTATION distance to neighboring elements

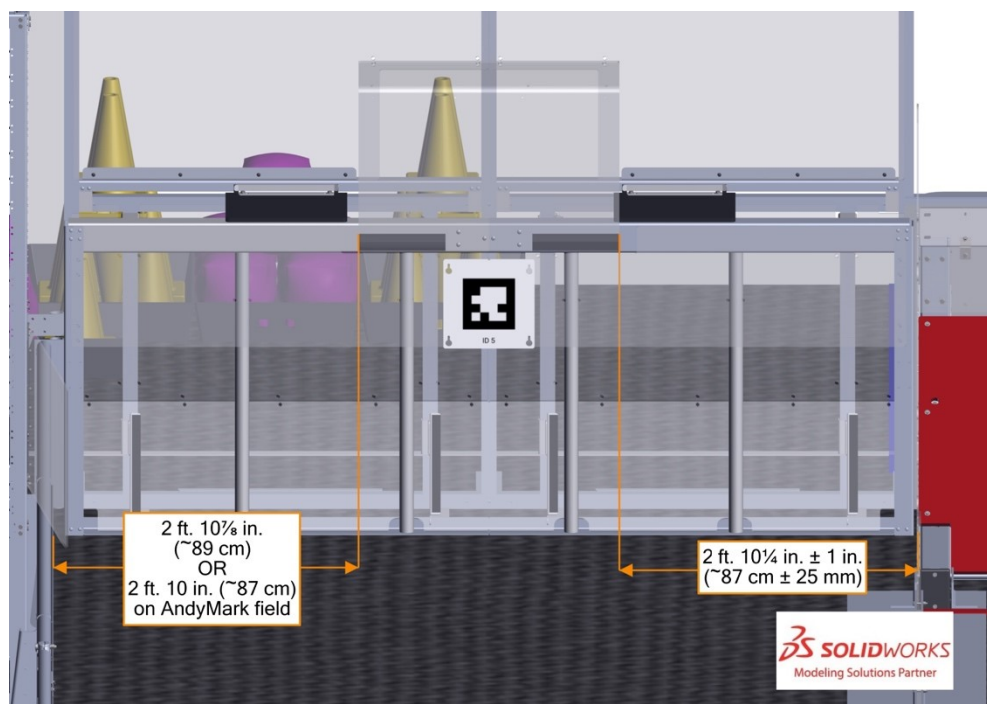

## 5.7 ALLIANCE WALLS

Figure 5-22 ALLIANCE WALL (click image to see field tour video)

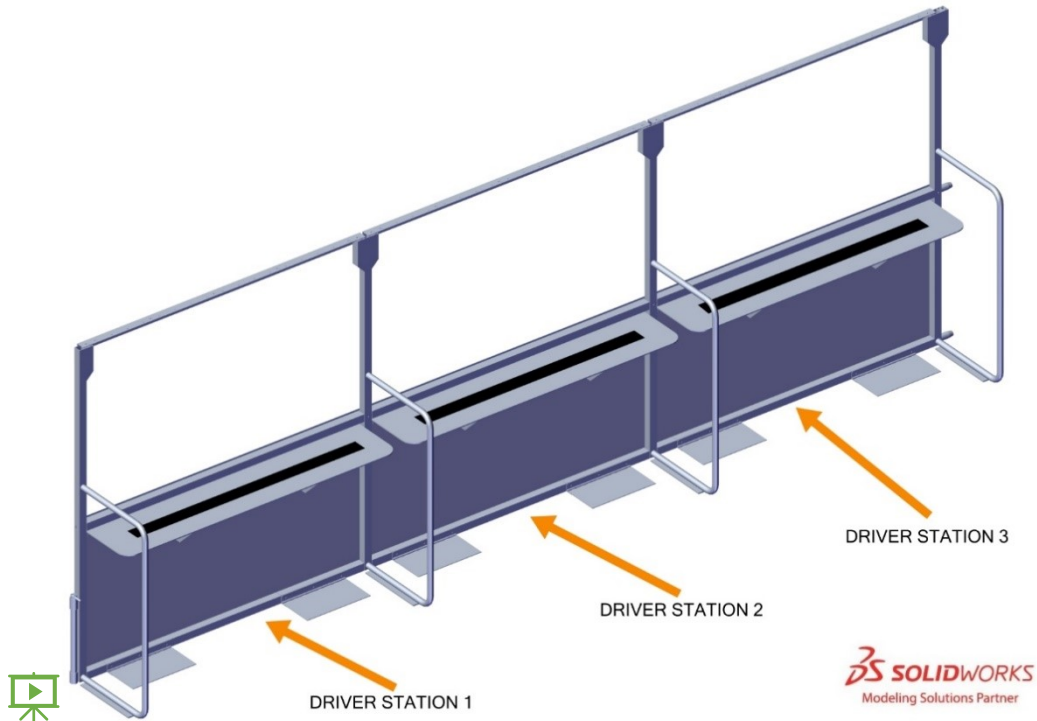

The ALLIANCE WALL separates ROBOTS from DRIVE TEAM members in the ALLIANCE AREA. It consists of 3 DRIVER STATIONS.

## 5.7.1 DRIVER STATIONS

Figure 5-23 DRIVER STATION dimensions

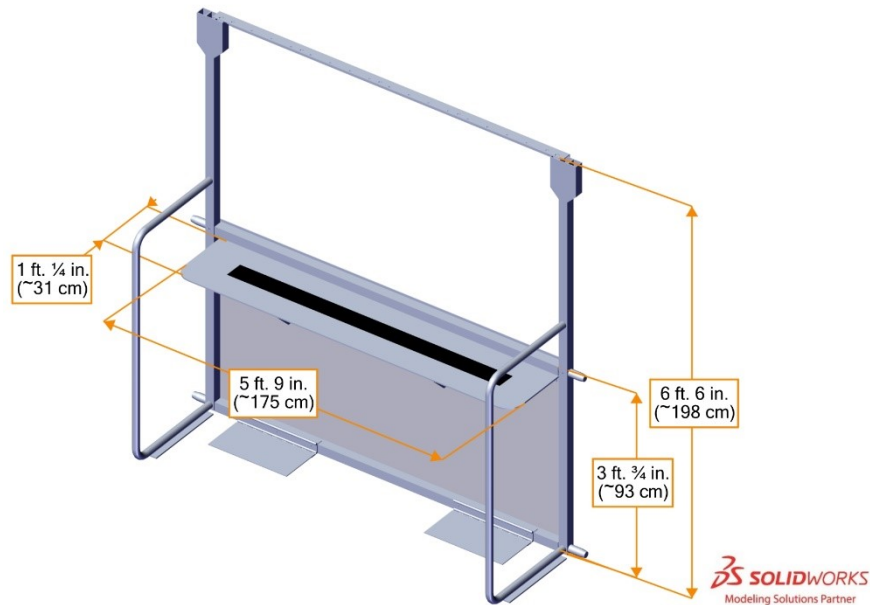

A DRIVER STATION is 1 of 3 assemblies within an ALLIANCE WALL behind which a DRIVE TEAM operates their ROBOT. Each DRIVER STATION is made from a 3 ft. 3/4 in. (~93 cm) tall diamond plate base topped with a 3 ft. 6 in. (~107 cm) tall transparent plastic sheet and a top rail. An aluminum shelf is attached to each DRIVER STATION to support an OPERATOR CONSOLE. The shelf is 5 ft. 9 in. (~175 cm) wide and 1 ft. 1/4 in. (~31 cm) deep. There is a 4 ft. 6 in. (~137 cm) long by 2 in. (nominal) wide strip of hook-and-loop tape (“loop” side) along the center of the support shelf that may be used to secure the OPERATOR CONSOLE to the shelf.

There may be a ramp available at events for DRIVE TEAMS with limited mobility. It is specially designed to allow an individual using a wheelchair to access the DRIVER STATION shelf and/or see onto the FIELD; however, this accommodation is available to anyone with an accessibility concern. Teams should speak to the FTA before MATCHES begin to ensure that it is available for each of the team’s MATCHES.

This ramp is available at many Regional and District events. For questions please connect with the local [Program Delivery Partner](#).

Each DRIVER STATION contains the following elements for DRIVE TEAMS:

- 1 Ethernet cable: attaches to the Ethernet port of the OPERATOR CONSOLE and provides connectivity to the Field Management System (FMS)
- 1 120VAC NEMA 5-15R power outlet (i.e. standard US outlet): located on each DRIVER STATION shelf and protected by its own 2-Amp circuit breaker. It can be used to power the OPERATOR CONSOLE. DRIVE TEAMS are responsible for monitoring their power consumption as a tripped breaker in the outlet does not constitute an ARENA FAULT. For some events in regions that don’t use NEMA 5-15 shaped outlets, event organizers may install appropriate plug adapters to be used throughout the event.



- 1 Emergency Stop (E-Stop) button: located on the left side of the DRIVER STATION shelf and is used to deactivate a ROBOT in an emergency
- 1 team sign: displays the team number and located at the top of each DRIVER STATION
- 1 team LED stack: indicates ALLIANCE color, ROBOT status, E-Stop status, and is centered at the top of each DRIVER STATION.

The stack includes 2 identical ALLIANCE-colored ROBOT status LEDs above a third amber E-stop LED. LED states are as follows:



- ROBOT status LEDs
  - Solid: indicates that the ROBOT is connected and enabled. This only happens during a MATCH.
  - Blinking: indicates that either the FMS is preset for the MATCH and the ROBOT is not connected yet, or it's during a MATCH and the corresponding ROBOT is BYPASSED, has lost connectivity, or the E-stop was pressed.
  - Off: indicates that the ROBOT is linked and DISABLED prior to the start of the MATCH. This light is also off, regardless of ROBOT connection status, after the MATCH has concluded.
- E-stop LED
  - Solid: the ROBOT is DISABLED due to a press of the team E-stop button, the FIELD E-stop button, or by the scorekeeper via the FMS.
  - Off: the ROBOT is not DISABLED by the FIELD.
- 1 string of LED nodes described in DRIVER STATION LED Strings.
- 1 timer (in DRIVER STATION 2 only): displays the official time remaining in the MATCH. It is marked with white tape along the bottom edge.
- FMS hardware and wiring: mostly located below the DRIVER STATION 2 shelf

### 5.7.1.1 DRIVER STATION LED Strings

A string of LED nodes is mounted to the bottom of each DRIVER STATION window frame. The string is used to communicate FIELD safety information, MATCH state, and GRID progress.

If the light string is all green, the FIELD is safe for humans.

Table 5-2 GRID light states ([field tour video](#))

Light String State	Criteria	Example
Off	Outside of a MATCH: FIELD is ready In MATCH: GAME PIECE scoring criteria not met	
Green	Head REFEREE has determined FIELD is safe for humans	

<b>ALLIANCE color (fills left to right when viewing from DRIVER STATION)</b>	LINK scored (1 LINK = 20% on, 2 LINKS = 40% of lights on, etc.)	
<b>4 outer nodes yellow</b>	DOCKED or ENGAGED scored during AUTO	
<b>ALLIANCE color and center 5 nodes are white</b>	SUSTAINABILITY BONUS criteria met	
<b>Magenta color (fills left to right, center DRIVER STATION only)</b>	COOPERTITION BONUS criteria met	
<b>White</b>	3 second scoring assessment period	
<b>Oscillating ALLIANCE color for 3 seconds</b>	Start of ENDGAME	

Light patterns layer as ALLIANCES score throughout the match.

Figure 5-24 Blue ALLIANCE example light pattern –

ENGAGED in AUTO with 1 LINK achieved

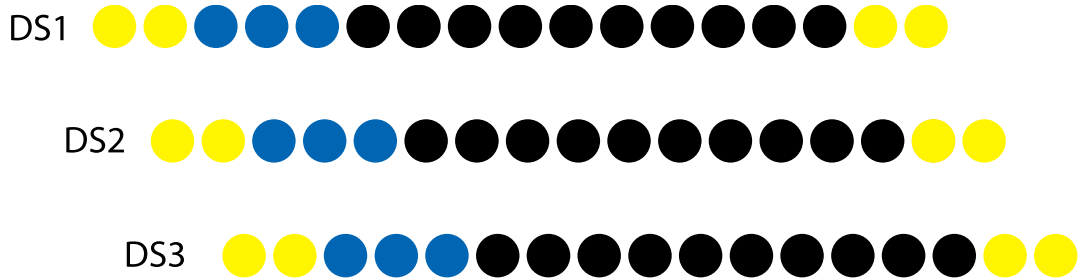
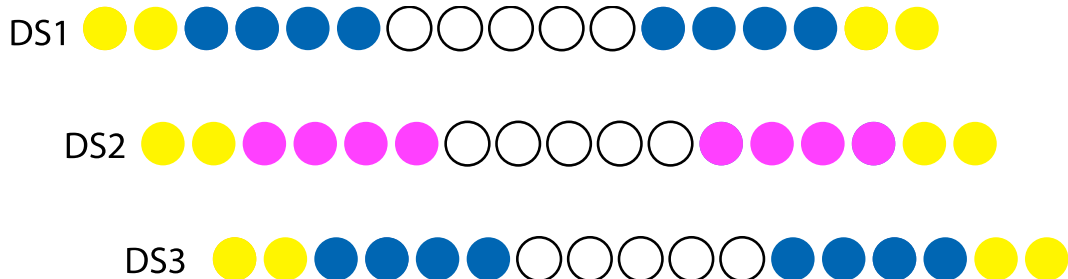

Figure 5-25 Blue ALLIANCE example light pattern –

ENGAGED in AUTO, 4 LINKS and COOPERTITION BONUS achieved



## 5.8 GAME PIECES

There are 2 types of GAME PIECES: CONES and CUBES.

### 5.8.1 CONE

Figure 5-26 CONE

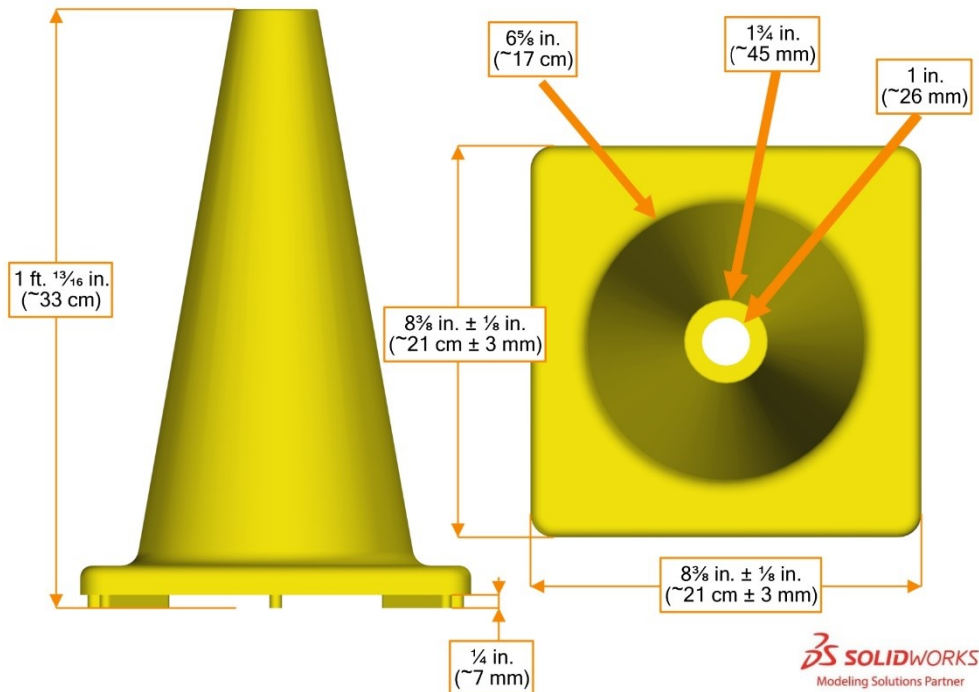

Each CONE is a yellow 1 ft.  $\frac{13}{16}$  in. (~33 cm) tall rubber marker cone and weighs 1lb 7oz (~653 g). Each CONE has an  $8\frac{3}{8}$  in. (~21 cm) +/-  $\frac{1}{8}$ in. (~3 mm) square base with  $\frac{1}{4}$  in. (~7 mm) tall feet. The rubber marker cone is made by Flaghouse (part number 4158) and sold by AndyMark, part number am-4700\_sync.



## 5.8.2 CUBE

Figure 5-27 CUBE



Each CUBE is made of purple PVC fabric and is marked with a *FIRST* logo, as shown in Figure 5-27. A CUBE is a cube-like shape, inflated to 9 ½ in. (~24 cm) +/- ¼ in. (~6 mm) as measured from face to face. A CUBE has rounded corners, may not have flat surfaces, and the length, width, and height of the sides may not be equal dimensions. A CUBE weighs 2.5 oz (~71 g). The inflatable cube is a modified version of a product made by Flaghouse (part number 17810) and sold by AndyMark, part number am-4700\_bpc. CUBES are expected to experience wear during MATCHES, and small holes may be patched with electrical tape. FIELD staff use a device to determine a CUBE'S dimensional compliance as shown in this [video](#).

Note that Flaghouse part number 17810 is not identical to a CUBE. The Flaghouse part varies in color and includes clear vinyl pouches on all sides, whereas a CUBE does not.

## 5.8.3 GAME PIECE Holders

GAME PIECES that begin the MATCH in the SUBSTATION AREA are stored in containers ([Uline part number S-24135](#)) located along the back edge each SUBSTATION AREA.

Figure 5-28 GAME PIECE Holders

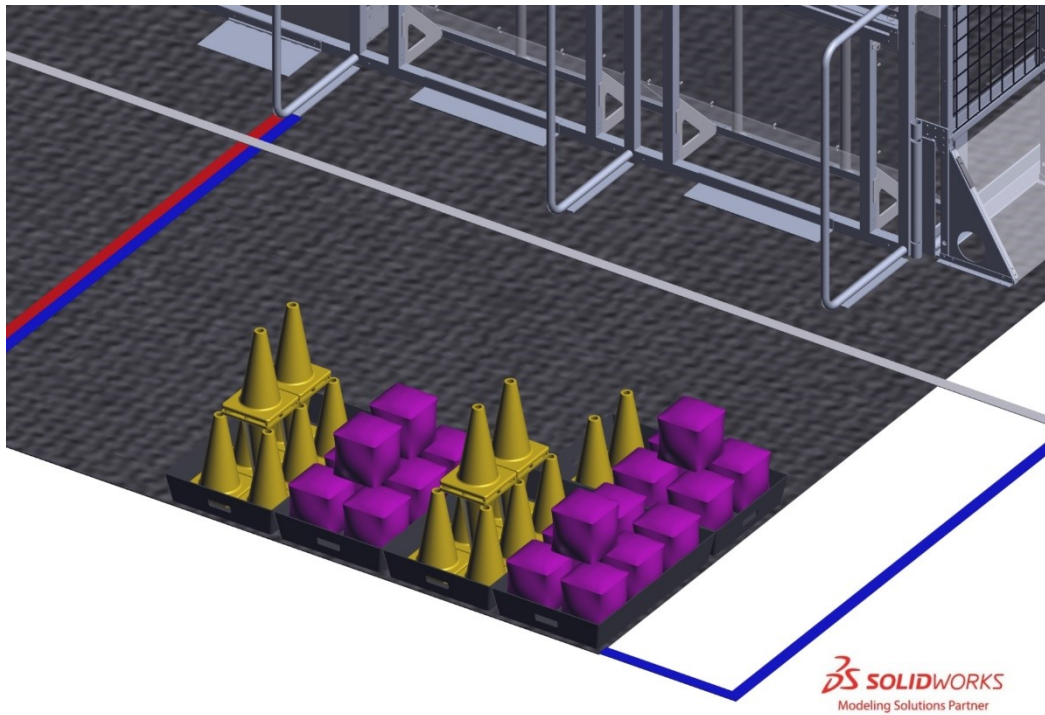

## 5.9 Vision Targets

Figure 5-29: Vision targets on a GRID and DOUBLE SUBSTATION

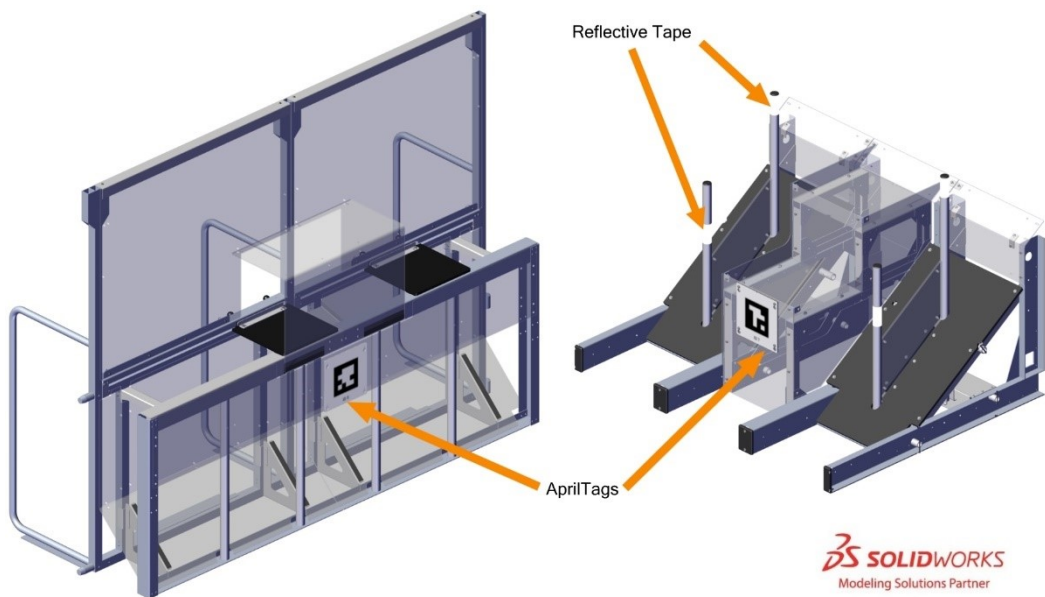

Vision targets are located on each GRID and DOUBLE SUBSTATION. There are 2 types of vision targets:

- reflective tape, and
- AprilTags.

Samples of the reflective tape material are included in each Kickoff Kit.

### 5.9.1 Reflective Tape

Reflective tape vision targets are made of 2 in. (~5 cm) thick strips of [3M 973-10 Diamond Grade Flexible Prismatic School Bus Marking Series White](#) and are used to highlight each CONE NODE.

A 4 in. (~10 cm) tall portion of each CONE NODE is wrapped with reflective tape. The tape is  $\frac{3}{16}$  in. (~5 mm) from the top of Top ROW CONE NODES and 8 in. (~20 cm) from the top of Middle ROW CONE NODES. This results in the bottom of the targets being 3 ft.  $\frac{5}{8}$  in. (~106 cm) and 1 ft.  $10\frac{1}{8}$  in. (~56 cm) from the FIELD carpet, as shown in Figure 5-30. Note that the reflective tape is likely hidden if a CONE is on the CONE NODE.

Figure 5-30 GRID retroreflective tape

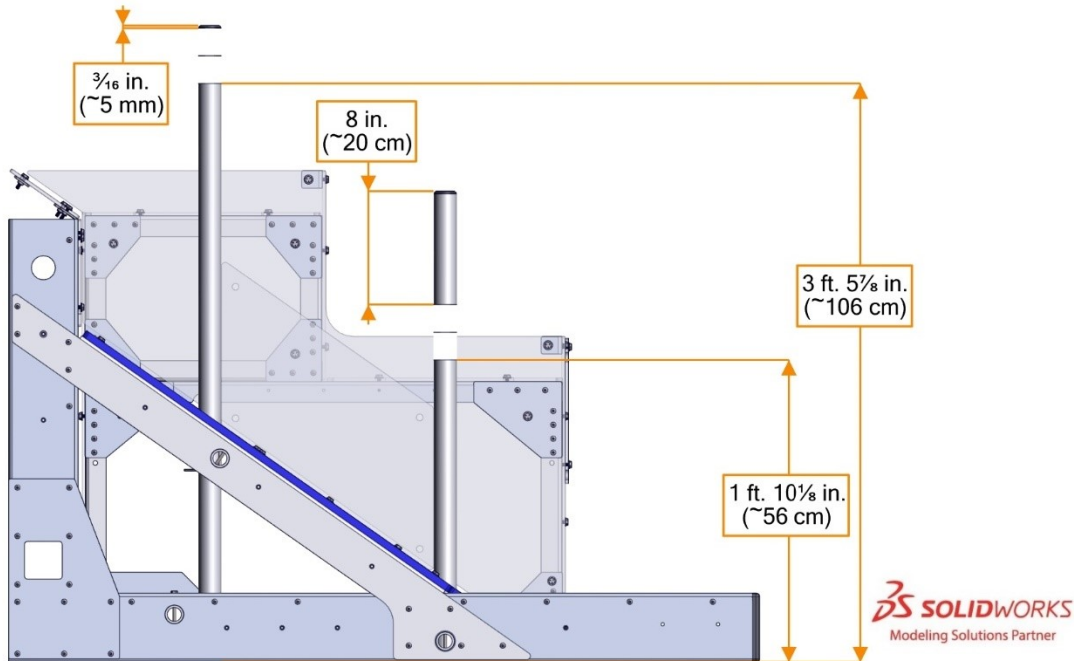

### 5.9.2 AprilTags

AprilTags are 8 in. (~20 cm) square targets located on the DOUBLE SUBSTATION and GRIDS. There are 8 unique markers on the FIELD, as shown in Figure 5-31.

Figure 5-31 AprilTag locations

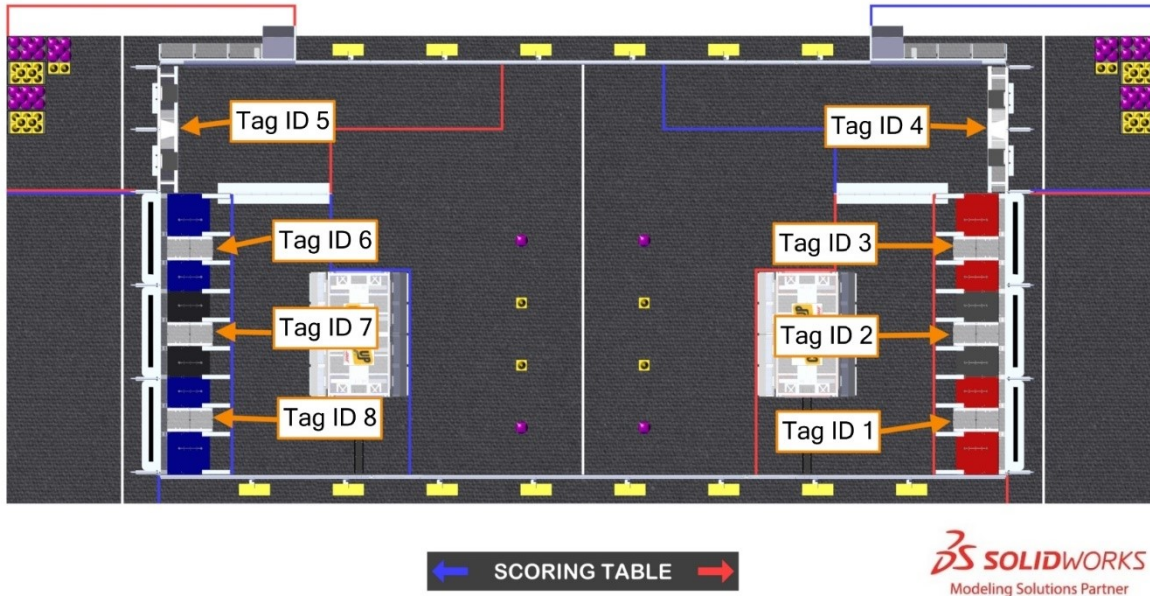

All markers are from the 16h5 tag family, IDs 1-8. AprilTags are mounted to and centered on a 10½ in. (~27 cm) square piece of polycarbonate. The 8 in. (~20 cm) tag is centered on the polycarbonate panel, such that the bottom of the central black square region is 2¼ in. (~6 cm) from the bottom of the panel, and the bottom of the 8 in. (~20 cm.) tag is located 1 ¼ in. (~3 cm) from the bottom of the panel as shown in Figure 5-32. Each marker has an identifying text label.

Figure 5-32 AprilTag sizing

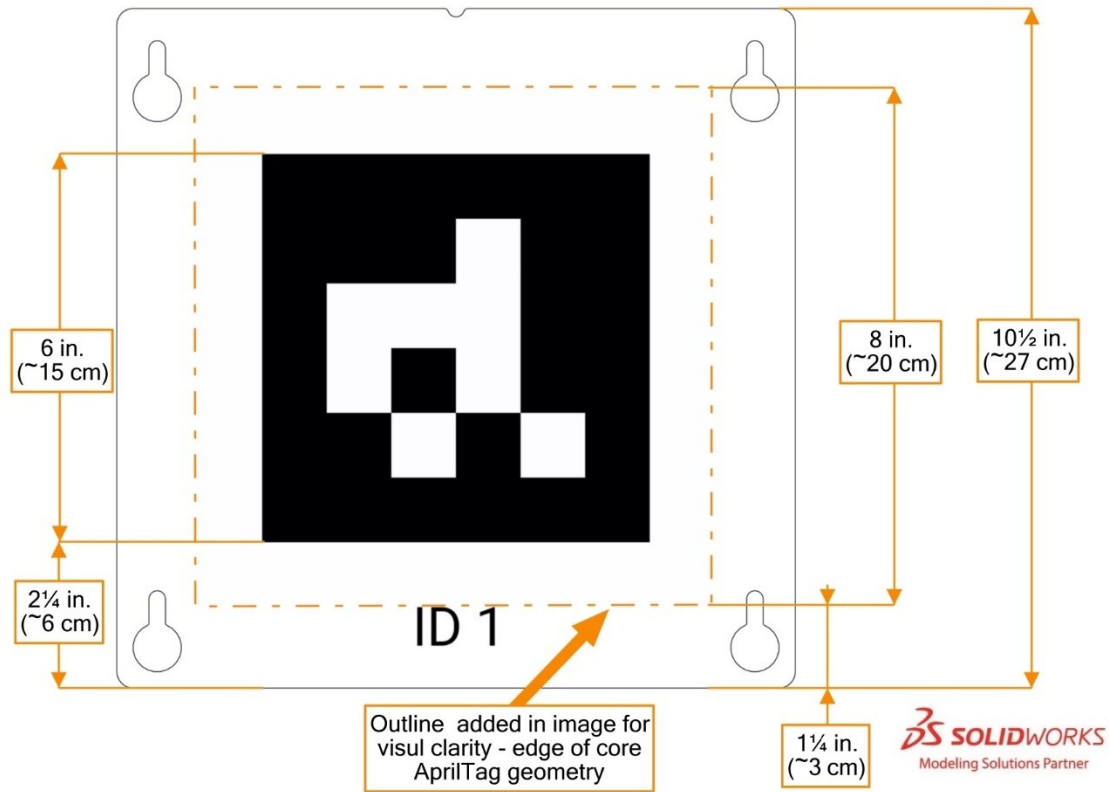

GRID AprilTags are centered on the width of the front face of the middle ROW CUBE NODES and elevated such that the distance from the carpet to the bottom of the AprilTag is 1 ft. 2 1/4 in. (~36 cm). Markers on the DOUBLE SUBSTATIONS are centered on the width of the assembly and are mounted such that the distance from the carpet to the bottom of the AprilTag is 1 ft. 11 3/8 in. (~59 cm).

Figure 5-33 AprilTag locating dimensions

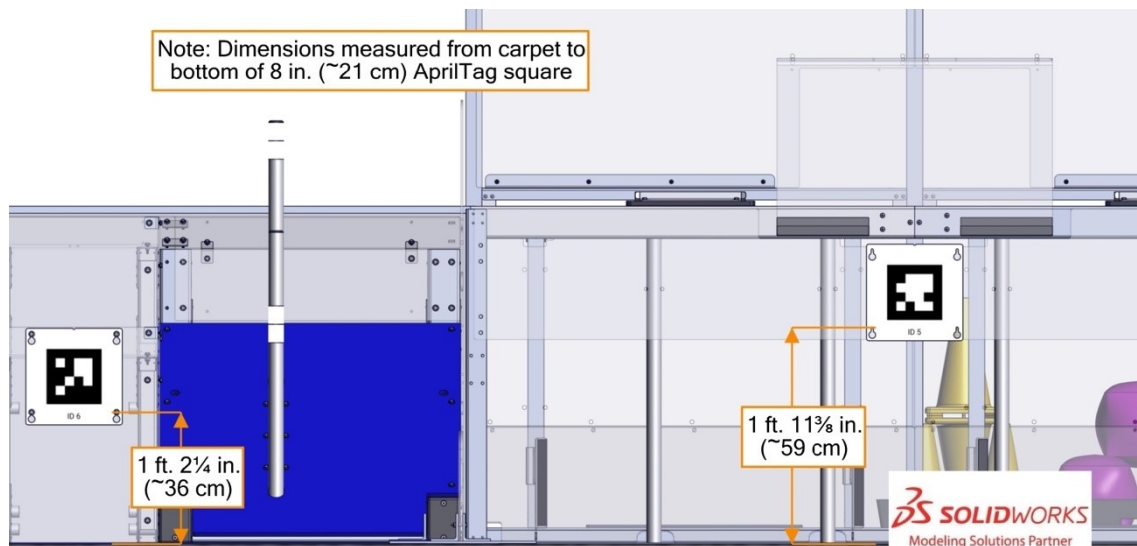



For further marker locating information please refer to the [2023 ARENA Layout and Marking Diagram](#). For printable versions of the markers, please refer to the [2023 Playing Field page](#).

## 5.10 The FIELD Management System

The FIELD Management System (FMS) is all electronics responsible for sensing and controlling the FIRST Robotics Competition FIELD. The FMS encompasses all FIELD electronics, including computers, REFEREE touchscreens, wireless access point, sensors, stack lights, E-Stops, etc.

When a DRIVE TEAM connects the Ethernet cable from their assigned DRIVER STATION to their OPERATOR CONSOLE, the Driver Station Software on the OPERATOR CONSOLE computer will communicate with FMS. Once connected, the open ports available are described in Table 9-5.

Note that ROBOT code cannot be deployed while connected to the FMS. Additional information about the FMS may be found in the [FMS Whitepaper](#).

The FMS alerts participants to milestones in the MATCH using audio cues detailed in Table 5-3. Please note that audio cues are intended as a courtesy to participants and not intended as official MATCH markers. If there is a discrepancy between an audio cue and the FIELD timers, the FIELD timers are the authority.

Table 5-3 Audio cues

Event	Timer Value	Audio Cue
<b>MATCH start</b>	0:15 (for AUTO)	“Cavalry Charge”
<b>AUTO ends</b>	0:00 (for AUTO)	“Buzzer”
<b>TELEOP begins</b>	2:15	“3 Bells”
<b>ENDGAME begins</b>	0: <b>Error! Reference source not found.</b>	“Train Whistle”
<b>MATCH end</b>	0:00	“Buzzer”
<b>MATCH stopped</b>	n/a	“Foghorn”



## 6 MATCH PLAY

During CHARGED UP, 2 ALLIANCES (an ALLIANCE is a cooperative of up to 4 FIRST Robotics Competition teams) play MATCHES, set up and implemented per the details described below.

### 6.1 Setup

Figure 6-1 MATCH setup

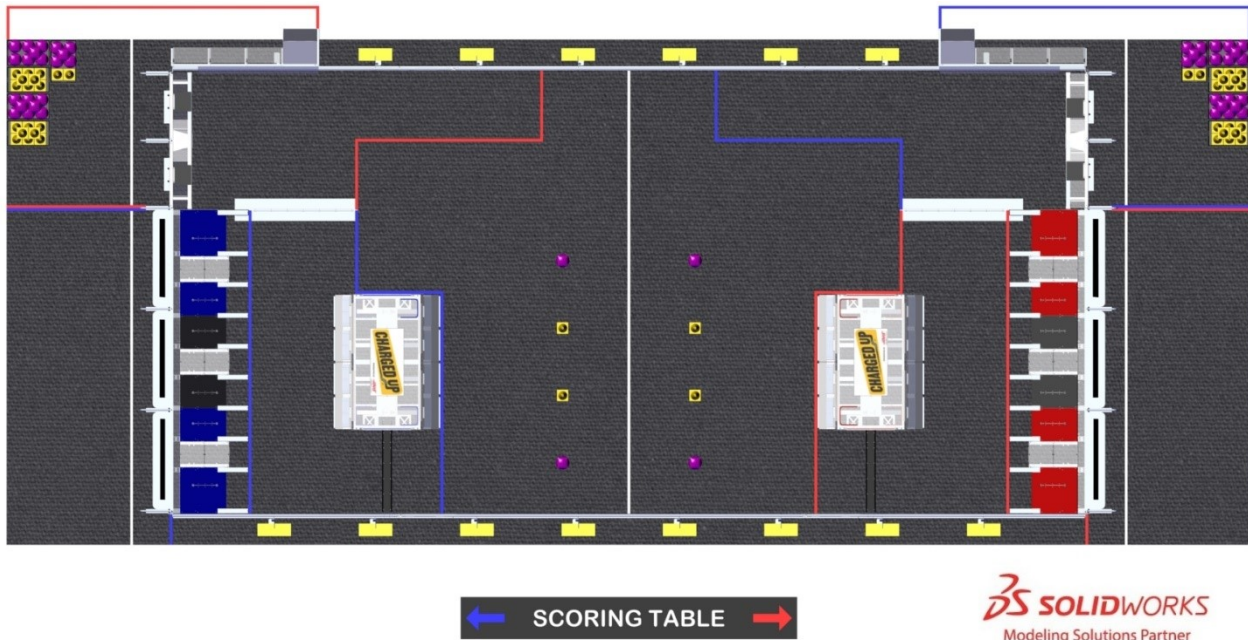

#### 6.1.1 GAME PIECES

54 CONES and 44 CUBES, divided evenly between the 2 ALLIANCES, are staged as follows:

- A. each ALLIANCE may preload 1 CONE or 1 CUBE in each ROBOT such that it is fully supported by that ROBOT,
- B. each ALLIANCE may stage 4 GAME PIECES of their choice on the STAGING MARKS as shown in Figure 6-1,
  - a. If no team decision, CUBES will be placed on the 2 outer marks and CONES will be placed on the 2 inner marks, and
- C. depending on decisions made in A and B remaining CONES (quantity 20 to 27) and CUBES (quantity 15 to 22) are staged in each of the corresponding ALLIANCE SUBSTATION AREAS.

#### 6.1.2 ROBOTS

Each DRIVE TEAM stages their ROBOT such that its BUMPERS are fully contained within their COMMUNITY and per the criteria outline in H309.

If order of placement matters to either or both ALLIANCES, the ALLIANCE must notify the Head REFEREE during setup for that MATCH. Upon notification, the Head REFEREE will require ALLIANCES to alternate placement of all ROBOTS. In a Qualification MATCH, ROBOTS are placed in the following order:

1. red DRIVER STATION 1 ROBOT
2. blue DRIVER STATION 1 ROBOT
3. red DRIVER STATION 2 ROBOT
4. blue DRIVER STATION 2 ROBOT
5. red DRIVER STATION 3 ROBOT
6. blue DRIVER STATION 3 ROBOT

In a Playoff MATCH, a similar pattern is applied with the lower seeded ALLIANCE placing first and alternating placement afterwards.

---

### 6.1.3 Humans

Humans stage for the MATCH as follows:

- A. DRIVERS and COACHES stage inside their ALLIANCE AREA and behind the STARTING LINE.
- B. HUMAN PLAYERS stage behind the STARTING LINE in either their SUBSTATION AREA or ALLIANCE AREA.
- C. TECHNICIANS stage in the event-designated area near the FIELD.

---

## 6.2 Autonomous Period

The first phase of each MATCH is 15 seconds long and called the Autonomous Period (AUTO). During AUTO, ROBOTS operate without any DRIVE TEAM control or input. ROBOTS attempt to score GAME PIECES on GRIDS, exit their ALLIANCE'S COMMUNITY, retrieve additional GAME PIECES, and DOCK on and/or ENGAGE with their CHARGE STATION before the end of the phase. There is a 3 second delay between AUTO and the Teleoperated Period during which time AUTO scores are assessed.

---

## 6.3 Teleoperated Period

The second phase of each MATCH is the remaining two minutes and fifteen seconds (2:15) and called the Teleoperated Period (TELEOP). During this phase, DRIVERS remotely operate ROBOTS to retrieve and score GAME PIECES.

The final thirty (0:30) seconds of the TELEOP stage is the ENDGAME, during which ROBOTS attempt to PARK, DOCK on, and/or ENGAGE with their ALLIANCE'S CHARGE STATION or continue to score GAME PIECES.

---

## 6.4 Scoring

ALLIANCES are rewarded for accomplishing various actions through the course of a MATCH, including demonstrating MOBILITY, scoring GAME PIECES on GRIDS, completing LINKS, DOCKING on and/or ENGAGING with their CHARGE STATION, PARKING, and winning or tying MATCHES.

Rewards are granted either via MATCH points or Ranking Points (sometimes abbreviated to RP, which increase the measure used to rank teams in the Qualification Tournament). Such actions, their criteria for completion, and their point values are listed throughout this section.

All scores are assessed and updated throughout the MATCH, except as follows:

- A. assessment of CHARGE STATION scoring occurs 3 seconds after the ARENA timer displays 0 following AUTO

- B. GAME PIECES scored in the GRID continues for up to 3 seconds after the ARENA timer displays 0 following AUTO.
- C. assessment of CHARGE STATION scoring occurs 3 seconds after the ARENA timer displays 0 following TELEOP
- D. GAME PIECES scored in the GRID continues for up to 3 seconds after the ARENA timer displays 0 following TELEOP.

If a GAME PIECE scored in AUTO gets removed from its NODE during TELEOP, the AUTO points are removed. If a GAME PIECE is scored in that NODE again, the AUTO points associated with the original scored GAME PIECE are restored.

All points are evaluated and scored by human volunteers. Teams are encouraged to make sure that it is obvious and unambiguous that a ROBOT or GAME PIECE has met the criteria.

### 6.4.1 GRID Scoring

ALLIANCES earn points by scoring GAME PIECES in NODES on their GRIDS. All GAME PIECES scored on the same ROW are worth equal value, as described in Table 6-2.

Table 6-1 GAME PIECE Scoring Criteria

ROW	GAME PIECE	Scoring Criteria
<b>Bottom</b>	CONE or CUBE	Touching FIELD carpet in only 1 HYBRID NODE and fully contained in GRIDS.
<b>Middle or Top</b>	CONE	The top of the CONE NODE is contained within the volume defined by the conical surface of the CONE
<b>Middle or Top</b>	CUBE	partially or completely (regardless of inflation state) supported by a CUBE NODE.

An ALLIANCE earns 1 LINK if 3 adjacent NODES in a ROW contains a scored GAME PIECE. A scored GAME PIECE only contributes towards 1 LINK at a time. LINKS are assessed in a manner that optimizes the number of LINKS awarded to an ALLIANCE.

Figure 6-2 LINK examples

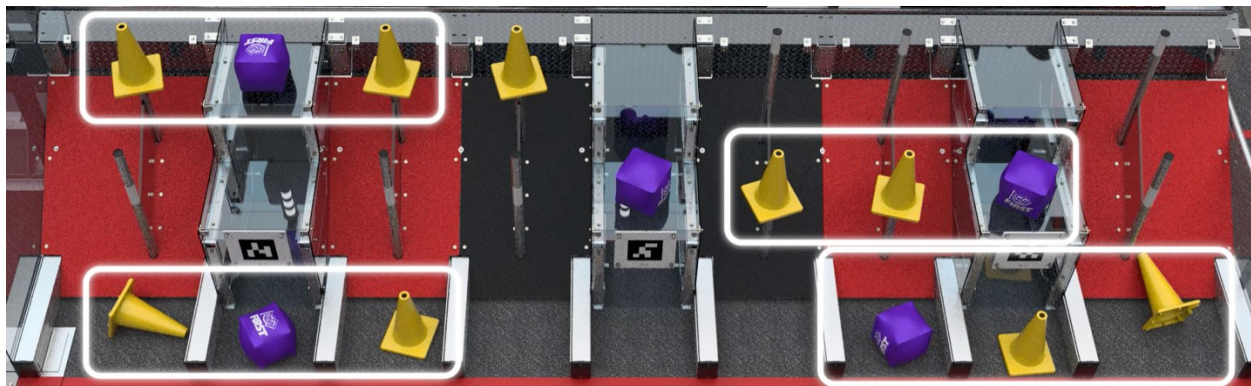

To be considered scored, a GAME PIECE may not be supported directly or transitively by an ALLIANCE ROBOT.

Only 1 GAME PIECE is counted per NODE.

### 6.4.2 CHARGE STATION Scoring

A ROBOT earns points for its ALLIANCE by DOCKING on or ENGAGING with their CHARGE STATION, as outlined in Table 6-2.

A ROBOT is DOCKED if it is contacting only the CHARGE STATION and/or other items also directly or transitively fully supported by the CHARGE STATION.

A ROBOT is ENGAGED if both of the following criteria are met:

- A. the CHARGE STATION is LEVEL, and
- B. all ALLIANCE ROBOTS contacting the CHARGE STATION are DOCKED.

### 6.4.3 Point Values

Point values for tasks in CHARGED UP are detailed in Table 6-2.

Table 6-2 CHARGED UP points

Award	Awarded for...	AUTO	TELEOP	Qual.	Playoff
<b>MOBILITY</b>	each ROBOT whose BUMPERS have completely left its COMMUNITY at any point during AUTO	3			
<b>GAME PIECES</b>	scored on a bottom ROW	3	2		
	scored on a middle ROW	4	3		
	scored on a top ROW	6	5		
<b>LINK</b>	3 adjacent NODES in a ROW contain scored GAME PIECES.		5		
<b>DOCKED and not ENGAGED</b>	Each ROBOT (1 ROBOT max in AUTO)	8	6		
<b>DOCKED and ENGAGED</b>	Each ROBOT (1 ROBOT max in AUTO)	12	10		
<b>PARK</b>	Each ROBOT whose BUMPERS are completely contained within its COMMUNITY but does not meet the criteria for DOCKED.		2		
<b>SUSTAINABILITY BONUS</b>	At least 5 LINKS scored.			1 Ranking Point	
<b>COOPERTITION BONUS</b>	At least 3 GAME PIECES scored on each ALLIANCE'S CO-OP GRID	The SUSTAINABILITY BONUS threshold is reduced to 4 LINKS for both ALLIANCES			



<b>ACTIVATION BONUS</b>	At least 26 total CHARGE STATION points earned in AUTO and/or ENDGAME.	1 Ranking Point
<b>Tie</b>	Completing a MATCH with the same number of MATCH points as your opponent.	1 Ranking Point
<b>Win</b>	Completing a MATCH with more MATCH points than your opponent.	2 Ranking Points

An ALLIANCE can earn up to 4 Ranking Points (RP) per Qualification MATCH, as described in Table 6-2. There are no Ranking Points in Playoff MATCHES.

## 6.5 Rule Violations

Upon any instance of a rule violation, unless otherwise noted, 1 or more of the penalties listed in Table 6-3 are assessed.

Table 6-3 Rule violations

Penalty	Description
<b>FOUL</b>	a credit of 5 points towards the opponent's MATCH point total
<b>TECH FOUL</b>	a credit of 12 points toward the opponent's MATCH point total
<b>YELLOW CARD</b>	a warning issued by the Head REFEREE for egregious ROBOT or team member behavior or rule violations. A subsequent YELLOW CARD within the same tournament phase results in a RED CARD.
<b>RED CARD</b>	a penalty assessed for egregious ROBOT or team member behavior or rule violations which results in a team being DISQUALIFIED for the MATCH.
<b>DISABLED</b>	the state in which a ROBOT is commanded to deactivate all outputs, rendering the ROBOT inoperable for the remainder of the MATCH.
<b>DISQUALIFIED</b>	the state of a team in which they receive 0 MATCH points and 0 Ranking Points in a Qualification MATCH or causes their ALLIANCE to receive 0 MATCH points in a Playoff MATCH

FIRST Robotics Competition uses 3 words in the context of how rules and violations are assessed in deliberate ways. These words provide general guidance to describe benchmarks to be used across the program. It is not the intent for REFEREES to provide a count during the time periods.

- **MOMENTARY** describes rule violations that happen for fewer than approximately 3 seconds.
- **CONTINUOUS** describes rule violations that happen for more than approximately 10 seconds.
- **REPEATED** describes rule violations that happen more than once within a MATCH.

See [Section 11.2.2 YELLOW and RED CARDS](#) for additional details.

### 6.5.1 Violation Details

There are several styles of violation wording used in this manual. Below are some example violations and a clarification of the way the violation would be assessed. The examples shown do not represent all possible violations, but rather a representative set of combinations.

Table 6-4 Violation examples

Example Violation	Expanded Interpretation
<b>FOUL</b>	Upon violation, a FOUL is assessed against the violating ALLIANCE.
<b>TECH FOUL and YELLOW CARD</b>	Upon violation, a TECH FOUL is assessed against the violating ALLIANCE. After the MATCH, the Head REFEREE presents the violating team with a YELLOW CARD.
<b>FOUL per additional GAME PIECES. If egregious, YELLOW CARD</b>	Upon violation, a number of FOULS are assessed against the violating ALLIANCE equal to the number of additional GAME PIECES beyond the permitted quantity. Additionally, if the REFEREES determine that the action was egregious, the Head REFEREE presents the violating team with a YELLOW CARD after the MATCH.
<b>TECH FOUL, plus an additional TECH FOUL for every 5 seconds in which the situation is not corrected</b>	Upon violation, a TECH FOUL is assessed against the violating ALLIANCE and the REFEREE begins to count. Their count continues until the criteria to discontinue the count are met, and for each 5 seconds within that time, an additional TECH FOUL is assessed against the violating ALLIANCE. A ROBOT in violation of this type of rule for 15 seconds receives a total of 4 TECH FOULS (assuming no other rules were being simultaneously violated).
<b>RED CARD for the ALLIANCE</b>	After the MATCH, the Head REFEREE presents the violating ALLIANCE with a RED CARD in the following fashion: <ul style="list-style-type: none"> <li>a) In a PLAYOFF MATCH, a single RED CARD is assessed to the ALLIANCE.</li> <li>b) In all other scenarios, each team on the ALLIANCE is issued a RED CARD.</li> </ul>

## 6.6 DRIVE TEAM

A DRIVE TEAM is a set of up to 5 people from the same FIRST Robotics Competition team responsible for team performance for a specific MATCH. There are 4 specific roles on a DRIVE TEAM which ALLIANCES can use to assist ROBOTS with CHARGED UP. Only 1 of the 5 DRIVE TEAM members is permitted to be a non-STUDENT.

The intent of the definition of DRIVE TEAM and DRIVE TEAM related rules is that, barring extenuating circumstances, the DRIVE TEAM consists of people who arrived at the event affiliated with that team and are responsible for their team's and ROBOT'S performance at the event (this means a person may be affiliated with more than 1 team). The intent is not to allow teams to "adopt" members of other teams for strategic advantage for the loaning team, borrowing team, and/or their ALLIANCE (e.g. an ALLIANCE CAPTAIN believes 1 of their DRIVERS has more experience than a DRIVER on their first pick, and the teams agree the first pick team will "adopt" that DRIVER and make them a member of their DRIVE TEAM for Playoffs).

The definition isn't stricter for 2 main reasons. First, to avoid additional bureaucratic burden on teams and event volunteers (e.g. requiring that teams

submit official rosters that Queuing must check before allowing a DRIVE TEAM into the ARENA). Second, to provide space for exceptional circumstances that give teams the opportunity to display *Gracious Professionalism* (e.g. a bus is delayed, a COACH has no DRIVERS, and their pit neighbors agree to help by loaning DRIVERS as temporary members of the team until their bus arrives).

Table 6-5 DRIVE TEAM roles

Role	Description	Max./ DRIVE TEAM	Criteria
<b>COACH</b>	a guide or advisor	1	any team member, must wear "COACH" button
<b>TECHNICIAN</b>	a resource for ROBOT troubleshooting, setup, and removal from the FIELD	1	any team member, must wear "TECHNICIAN" button
<b>DRIVER</b>	an operator and controller of the ROBOT	3	STUDENT, must wear a "DRIVE TEAM" button
<b>HUMAN PLAYER</b>	a GAME PIECE manager		

A STUDENT is a person who has not completed high-school, secondary school, or the comparable level as of September 1 prior to Kickoff.

The TECHNICIAN provides teams with a technical resource for pre-MATCH setup, ROBOT connectivity, OPERATOR CONSOLE troubleshooting, and post-MATCH removal of the ROBOT. Some pre-MATCH responsibilities for the TECHNICIAN may include, but are not limited to:

- location of the ROBOT radio, its power connection, and understanding of its indicator lights,
- location of the roboRIO and understanding of its indicator lights,
- username and password for the OPERATOR CONSOLE,
- restarting the Driver Station and Dashboard software on the OPERATOR CONSOLE,
- changing the bandwidth utilization (e.g. camera resolution, frame rate, etc.),
- changing a battery, or
- charging pneumatics.

While the TECHNICIAN may be the primary technical member of the DRIVE TEAM, all members of the DRIVE TEAM are encouraged to have knowledge of the basic functionality of the ROBOT, such as the location and operation of the main circuit breaker, connecting and resetting joysticks or gamepads from the OPERATOR CONSOLE, and removing the ROBOT from the FIELD.

## 6.7 Other Logistics

---

GAME PIECES that leave the FIELD are placed back into the FIELD approximately at the point of exit by FIELD STAFF (REFEREES, *FIRST* Technical Advisors (FTAs), or other staff working around the FIELD) at the earliest safe opportunity.

Note that ROBOTS may not deliberately cause GAME PIECES to leave the FIELD (see [G401](#)).

An ARENA FAULT is not called for MATCHES that accidentally begin with damaged GAME PIECES. Damaged GAME PIECES are not replaced until the next ARENA reset period. DRIVE TEAMS should alert the FIELD STAFF to any missing or damaged GAME PIECES prior to the start of the MATCH.

Once the MATCH is over and the Head REFEREE determines that the FIELD is safe for FIELD STAFF and DRIVE TEAMS, they or their designee change the LED lights to green and DRIVE TEAMS may retrieve their ROBOT.

In addition to the 2 minutes and 30 seconds (2:30) of game play, each MATCH also has pre- and post-MATCH time to reset the ARENA. During ARENA reset, the ARENA is cleared of ROBOTS and OPERATOR CONSOLES from the MATCH that just ended, ROBOTS and OPERATOR CONSOLES for the subsequent MATCH are loaded into the ARENA by DRIVE TEAMS, and FIELD STAFF reset ARENA elements.



## 7 GAME RULES: ROBOTS

### 7.1 ROBOT Restrictions

- G101** **\*Dangerous ROBOTS: not allowed.** ROBOTS whose operation or design is dangerous or unsafe are not permitted.

*Violation: If before the MATCH, the offending ROBOT will not be allowed to participate in the MATCH. If during the MATCH, the offending ROBOT will be DISABLED.*

Examples include, but are not limited to:

- uncontrolled motion that cannot be stopped by the DRIVE TEAM,
- ROBOT parts “flailing” outside of the FIELD,
- ROBOTS dragging their battery, and
- ROBOTS that consistently extend outside the FIELD.

- G102** **\*ROBOTS, stay on the FIELD during the MATCH.** ROBOTS and anything they control, e.g. GAME PIECES, may not contact anything outside the FIELD except for MOMENTARY incursions into PORTALS.

*Violation: DISABLED.*

Please be conscious of REFEREES and FIELD STAFF working around the ARENA who may be in close proximity to your ROBOT.

- G103** **\*Keep your BUMPERS low.** BUMPERS must be in the BUMPER ZONE (see [R402](#)) during the MATCH.

*Violation: FOUL. If REPEATED or greater than MOMENTARY, DISABLED.*

- G104** **\*Keep your BUMPERS together.** BUMPERS may not fail such that a segment completely detaches, any corner (as defined in [R401](#)) of a ROBOT’S FRAME PERIMETER is exposed, or the team number or ALLIANCE color are indeterminate.

*Violation: DISABLED.*

- G105** **\*Keep it together.** ROBOTS may not intentionally detach or leave parts on the FIELD.

*Violation: RED CARD.*

- G106** **Tall ROBOTS not allowed.** ROBOT height, as measured when it’s resting normally on a flat floor, may not exceed 6 ft. 6 in. (~198 cm)) above the carpet during the MATCH.

*Violation: FOUL.*

This measurement is intended to be made as if the ROBOT is resting on a flat floor, not relative to the height of the ROBOT from the FIELD carpet.

For example, a ROBOT that is at an angle while driving over something may actually exceed the height limit when compared to the carpet of the FIELD.



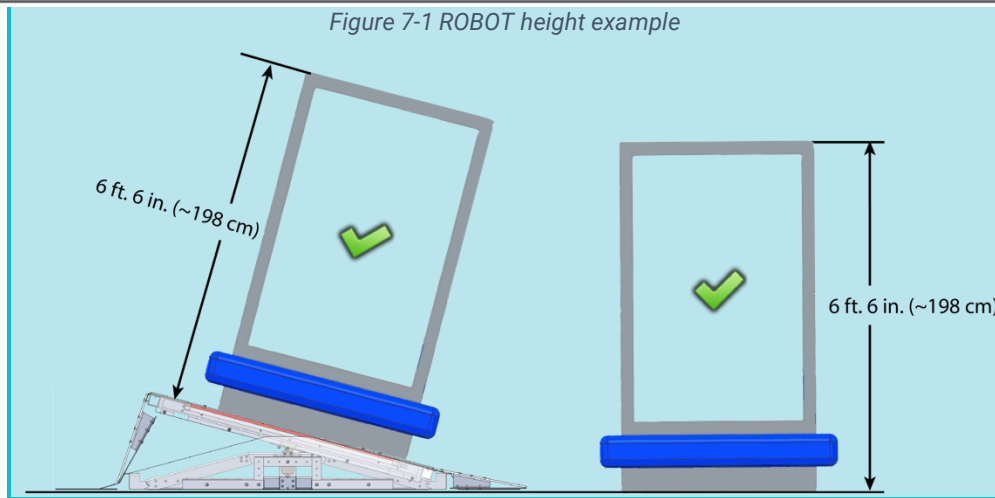

- G107 Don't overextend yourself.** ROBOTS may not extend beyond their FRAME PERIMETER in more than 48 in. (~122 cm). MOMENTARY and inconsequential extensions beyond 48 in. (~122 cm) are an exception to this rule.

*Violation: FOUL. TECH FOUL if the over-extension scores a GAME PIECE. If the over-extension results in the ROBOT blocking all access to a FIELD ELEMENT, RED CARD*

MOMENTARY and inconsequential extensions include a wire or cable tie swinging out of the FRAME PERIMETER, including while an extension is deployed.

Examples of compliance and non-compliance of this rule are shown in Figure 7-2.

Yellow bars represent the limits of the FRAME PERIMETER and are drawn in the same orientation of the ROBOT'S FRAME PERIMETER. Green bars represent a measured extension from the FRAME PERIMETER that does not exceed the limit defined in this rule. Red bars represent a measured extension from the FRAME PERIMETER that exceeds the limit in this rule.

- ROBOT A violates this rule for having an extension that is too long
- ROBOT B does not violate this rule
- ROBOT C does not violate this rule
- ROBOT D does not violate this rule because its extension is only extending in one direction despite edges that are non-perpendicular to the ROBOT BUMPERS

Figure 7-2 Examples of compliance and non-compliance of this rule

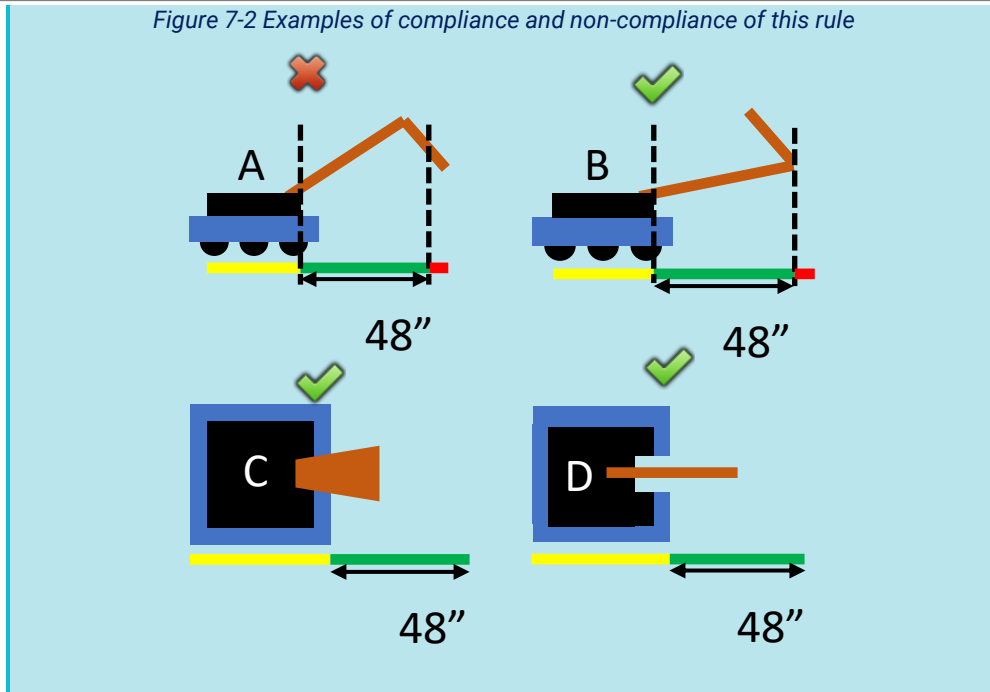

- G108 Opponent's zone, no extension.** A ROBOT whose BUMPERS are intersecting the opponent's LOADING ZONE or COMMUNITY may not extend beyond its FRAME PERIMETER. Extensions which are both MOMENTARY and inconsequential are an exception to this rule.

*Violation: FOUL. If REPEATED, TECH FOUL per instance.*

Examples of MOMENTARY and inconsequential extensions include a wire or cable tie swinging out of the FRAME PERIMETER.

- G109 Don't extend in multiple directions.** ROBOTS may not extend beyond their FRAME PERIMETER in more than one direction (i.e. over 1 side of the ROBOT) at a time. For the purposes of this rule, a round or circular section of FRAME PERIMETER is considered to have an infinite number of sides. Exceptions to this rule are:

- A. MOMENTARY and inconsequential extensions in multiple directions
- B. A ROBOT fully contained within its LOADING ZONE or COMMUNITY.

*Violation: FOUL. TECH FOUL if extending in multiple directions scores a GAME PIECE. If extending in multiple directions results in the ROBOT blocking all access to a FIELD ELEMENT, RED CARD*

MOMENTARY and inconsequential actions include a wire or cable tie swinging out of the FRAME PERIMETER, including while an extension is deployed.

Examples of compliance and non-compliance of this rule are shown in Figure 7-3.

Yellow bars represent the limits of the FRAME PERIMETER and are drawn in the same orientation of the ROBOT'S FRAME PERIMETER. Green bars represent a measured extension from the FRAME PERIMETER that does not exceed the limit defined in this rule. Red bars represent a measured extension from the FRAME PERIMETER that exceeds the limit in this rule.

All following examples are legal in ROBOT'S LOADING ZONE and COMMUNITY.

- ROBOT A violates this rule for extending in more than one direction
- ROBOT B violates this rule for extending in more than one direction

- ROBOT C violates this rule for extending beyond an infinite number of sides and therefore any extension over an arc extends over multiple sides
- ROBOT D does not violate this rule
- ROBOT E violates this rule for extending in more than one direction
- ROBOT F violates this rule for extending in more than one direction
- ROBOT G does not violate this rule as long as the extension does not exceed the definition of MOMENTARY when positioned over the BUMPER corner.

Figure 7-3 Examples of compliance and non-compliance of this rule

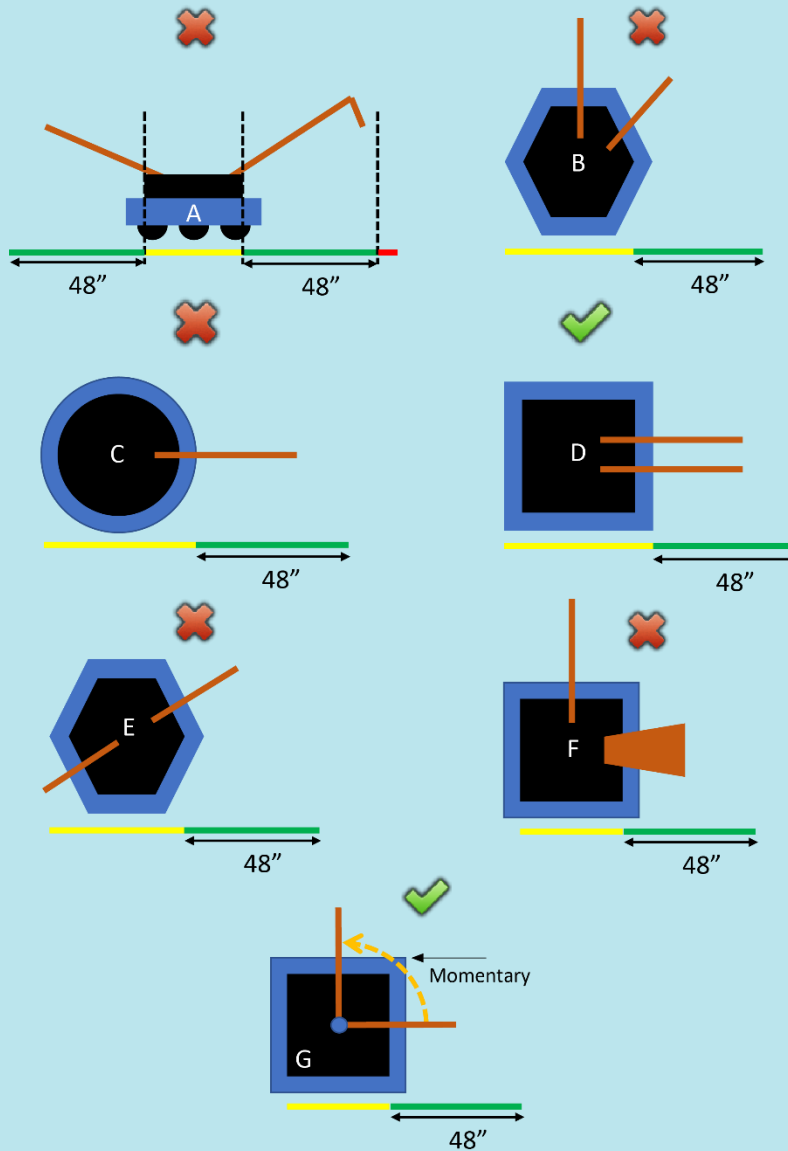

## 7.2 ROBOT to ROBOT Interaction

**G201** \*Don't expect to gain by doing others harm. Strategies clearly aimed at forcing the opponent ALLIANCE to violate a rule are not in the spirit of FIRST Robotics Competition and not allowed. Rule violations forced in this manner will not result in an assignment of a penalty to the targeted ALLIANCE.

*Violation: FOUL. If REPEATED, TECH FOUL.*

This rule does not apply for strategies consistent with standard gameplay, for example a red ALLIANCE ROBOT in their COMMUNITY in the final 30 seconds of the MATCH contacts a blue ALLIANCE ROBOT.

This rule requires an intentional act with limited or no opportunity for the team being acted on to avoid the penalty, such as:

- a. forcing the opposing ROBOT to have greater than MOMENTARY CONTROL of more than 1 GAME PIECE.
- b. a blue ALLIANCE ROBOT pushing a red ALLIANCE ROBOT from fully outside the blue LOADING ZONE into the blue LOADING ZONE

- G202** **\*There's a 5-count on PINS.** ROBOTS may not PIN an opponent's ROBOT for more than 5 seconds. A ROBOT is PINNING if it is preventing the movement of an opponent ROBOT by contact, either direct or transitive (such as against a FIELD element). A ROBOT is considered PINNED until the ROBOTS have separated by at least 6 ft. (~183 cm) from each other, either ROBOT has moved 6 ft. from where the PIN initiated, or the PINNING ROBOT gets PINNED, whichever comes first. The PINNING ROBOT(S) must then wait for at least 3 seconds before attempting to PIN the same ROBOT again.

*Violation: FOUL, plus an additional TECH FOUL for every 5 seconds in which the situation is not corrected.*

A team's desired direction of travel is not a consideration when determining if a ROBOT is PINNED.

If the PINNING ROBOT gets PINNED, the original PIN count terminates. Otherwise, if a ROBOT re-PINS the same ROBOT before the 3 seconds referenced in the last sentence of this rule, the REFEREE'S count resumes from the initial PIN (versus starting at 0).

- G203** **\*Don't collude with your partners to shut down major parts of game play.** 2 or more ROBOTS that appear to a REFEREE to be working together may neither isolate nor close off any major element of MATCH play.

*Violation: TECH FOUL, plus an additional TECH FOUL for every 5 seconds in which the situation is not corrected.*

Examples of violations of this rule include, but are not limited to:

- a. shutting down access to all GAME PIECES,
- b. quarantining all opponents to a small area of the FIELD,
- c. blocking all access to the LOADING ZONE, and
- d. blocking all access to the COMMUNITY

A single ROBOT blocking access to a particular area of the FIELD is not a violation of this rule.

2 ROBOTS independently playing defense on 2 opponent ROBOTS is not a violation of this rule.

Note, [G204](#), [G205](#), and [G206](#) are mutually exclusive. A single ROBOT to ROBOT interaction which violates more than 1 of these rules results in the most punitive penalty, and only the most punitive penalty, being assessed.

- G204** \***Stay out of other ROBOTS.** A ROBOT may not use a COMPONENT outside its FRAME PERIMETER (except its BUMPERS) to initiate contact with an opponent ROBOT inside the vertical projection of that opponent ROBOT'S FRAME PERIMETER. Contact with an opponent in an opening of their BUMPERS or in the space above the BUMPER opening are exceptions to this rule.

*Violation: FOUL.*

For the purposes of this rule, "initiate contact" requires movement towards an opponent ROBOT.

In a collision, it's possible for both ROBOTS to initiate contact.

- G205** \***This isn't combat robotics.** A ROBOT may not damage or functionally impair an opponent ROBOT in either of the following ways:

- A. deliberately, as perceived by a REFEREE.
- B. regardless of intent, by initiating contact inside the vertical projection of an opponent ROBOT'S FRAME PERIMETER. Contact between the ROBOT'S BUMPERS or COMPONENTS inside the ROBOT'S FRAME PERIMETER and COMPONENTS inside an opening of an opponent's BUMPERS is an exception to this rule.

*Violation: TECH FOUL and YELLOW CARD. If opponent ROBOT is unable to drive, TECH FOUL and RED CARD*

FIRST Robotics Competition can be a full-contact competition and may include rigorous game play. While this rule aims to limit severe damage to ROBOTS, teams should design their ROBOTS to be robust.

The exception in [G205-B](#) effectively means that ROBOTS with BUMPER gaps are at their own risk regarding damaging contact in these areas.

Examples of violations of this rule include, but are not limited to:

- a. A ROBOT leaves an arm extended, spins around to change course, and unintentionally hits and damages a COMPONENT inside the FRAME PERIMETER of a nearby opponent ROBOT.
- b. A ROBOT, in the process of trying to quickly reverse direction, tips up on a single pair of wheels, lands atop an opponent ROBOT, and damages a COMPONENT inside that opponent's FRAME PERIMETER.
- c. A ROBOT high-speed rams and/or REPEATEDLY smashes an opponent ROBOT and causes damage. The REFEREE infers that the ROBOT was deliberately trying to damage the opponent's ROBOT.

Examples of functionally impairing another ROBOT include, but are not limited to:

- d. opening an opponent's relief valve such that the opponent's air pressure drops and
- e. powering off an opponent's ROBOT (this example also clearly results in a RED CARD because the ROBOT is no longer able to drive).

At the conclusion of the MATCH, the Head REFEREE may elect to visually inspect a ROBOT to confirm violations of this rule made during a MATCH and remove the violation if the damage cannot be verified.

For the purposes of this rule, "initiating contact" requires movement towards an opponent ROBOT.

In a collision, it's possible for both ROBOTS to initiate contact.



**G206** \*Don't tip or entangle. A ROBOT may not deliberately, as perceived by a REFEREE, attach to, tip, or entangle with an opponent ROBOT.

*Violation: TECH FOUL and YELLOW CARD. If CONTINUOUS or opponent ROBOT is unable to drive, TECH FOUL and RED CARD.*

Examples of violations of this rule include, but are not limited to:

- using a wedge-like MECHANISM to tip over opponent ROBOTS,
- making BUMPER-to-BUMPER contact with an opponent ROBOT that is attempting to right itself after previously falling over and causing them to fall over again, and
- causing an opponent ROBOT to tip over by contacting the ROBOT after it starts to tip if, in the judgement of the REFEREE, that contact could have been avoided.

Tipping as an unintended consequence of normal ROBOT to ROBOT interaction, as perceived by the REFEREE, is not a violation of this rule.

"Unable to drive" means that because of the incident, the DRIVER can no longer drive to a desired location in a reasonable time (generally). For example, if a ROBOT can only move in circles, or can only move extremely slowly, the ROBOT is considered unable to drive.

**G207** Right of way. A ROBOT with any part of itself in their opponent's LOADING ZONE or COMMUNITY may not contact an opponent ROBOT, regardless of who initiates contact.

*Violation: FOUL per instance.*

Teams should take note that they are putting themselves at great risk for FOULS if they choose to enter their opponent's LOADING ZONE or COMMUNITY.

Figure 7-4: G207 Examples



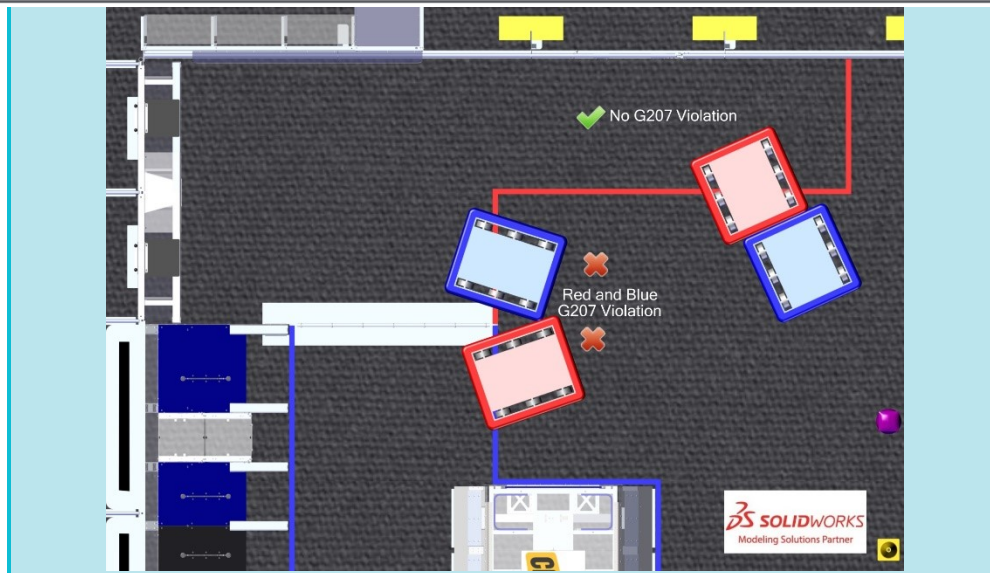

**G208** **Don't climb on each other unless in the COMMUNITY.** A ROBOT may not be fully supported by a partner ROBOT unless the partner's BUMPERS intersect its COMMUNITY.

*Violation: TECH FOUL per instance.*

**G209** **During the ENDGAME, don't touch ROBOTS touching their CHARGE STATION.** During the ENDGAME, a ROBOT may not contact, either directly or transitively through a GAME PIECE, an opponent ROBOT contacting its CHARGE STATION or supported by a partner contacting its CHARGE STATION, regardless of who initiates contact. A ROBOT in contact with its CHARGE STATION and partially in its opponent's LOADING ZONE is not protected by this rule.

*Violation: The contacted opponent ROBOT, and any ROBOTS contacting their CHARGE STATION when the violation occurred, and any partners its supporting, will be considered DOCKED and ENGAGED.*

## 7.3 FIELD Interaction

**G301** **Be careful what you interact with.** ROBOTS and OPERATOR CONSOLES are prohibited from the following actions with regards to interaction with ARENA elements. Items A-D exclude GAME PIECES.

- A. grabbing,
- B. grasping,
- C. attaching to (including the use of a vacuum or hook fastener to anchor to the FIELD carpet and excluding use of the DRIVER STATION hook-and-loop tape, plugging in to the provided power outlet, and plugging the provided Ethernet cable into the OPERATOR CONSOLE),
- D. deforming,
- E. becoming entangled with,
- F. suspending from, and
- G. damaging.

*Violation: MATCH won't start until the situation is corrected. If during a MATCH, TECH FOUL. If during a MATCH and REPEATED or longer than MOMENTARY, YELLOW CARD. If offense is via a ROBOT and the Head REFEREE determines that further damage is likely to occur, offending ROBOT will be DISABLED. Corrective action (such as eliminating sharp edges, removing the damaging*

*MECHANISM, and/or re-inspection) may be required before the ROBOT will be allowed to compete in subsequent MATCHES.*

GAME PIECES are expected to undergo a reasonable amount of wear and tear as they are handled by ROBOTS, such as scratching or marking. Gouging, popping, tearing off pieces, or routinely marking GAME PIECES are violations of this rule.

**G302 Stay on your side in AUTO.** During AUTO, a ROBOT may not intersect the infinite vertical volume created by the CENTERLINE of the FIELD.

*Violation: FOUL. If contact with an opponent ROBOT, TECH FOUL. If contact with opponent's CHARGE STATION, the opponent ALLIANCE will be considered to have a successfully DOCKED and ENGAGED ROBOT at the end of AUTO.*

If an ALLIANCE uses a GAME PIECE to prevent motion of the CHARGE STATION, [G402](#) may also apply.

**G303 Do not interfere with opponent GAME PIECES in AUTO.** During AUTO, a ROBOT action may not cause GAME PIECES staged on the opposing side of the FIELD to move from their starting locations.

*Violation: TECH FOUL per moved GAME PIECE*

**G304 Don't mess with the opponent's CHARGE STATION.** ROBOTS, either directly or transitively through a GAME PIECE, may not cause or prevent the movement of the opponent CHARGE STATION. The following are exceptions to this rule:

- A. movement, or prevention of movement, of an opponent CHARGE STATION because of a MOMENTARY ROBOT action resulting in minimal CHARGE STATION movement
- B. a ROBOT forced to contact an opponent's CHARGE STATION because of contact by an opponent ROBOT, either directly or transitively through a GAME PIECE or other ROBOT (e.g. a ROBOT wedged underneath the CHARGE STATION by the opposing ALLIANCE either intentionally or accidentally).

*Violation: FOUL per instance. During the ENDGAME, any ROBOTS contacting their CHARGE STATION when the violation occurred, and any partners its supporting, will be considered DOCKED and ENGAGED*

**G305 Don't trick the sensors.** Teams may not interfere with automated scoring hardware.

*Violation: RED CARD for the ALLIANCE*

## 7.4 GAME PIECES

**G401 \*Keep GAME PIECES in bounds.** ROBOTS may not intentionally eject GAME PIECES from the FIELD (either directly or by bouncing off a FIELD element or other ROBOT).

*Violation: FOUL per GAME PIECE.*

**G402 \*GAME PIECES: use as directed.** ROBOTS may not deliberately use GAME PIECES in an attempt to ease or amplify challenges associated with FIELD elements.

*Violation: TECH FOUL per GAME PIECE.*

Examples include, but are not limited to:

- a. wedging a CUBE under the CHARGE STATION to ease ENGAGING and
- b. placing a CONE on the opponent's CHARGE STATION to make it harder to drive on.

**G403 1 GAME PIECE at a time (except in LOADING ZONE and COMMUNITY).** ROBOTS completely outside their LOADING ZONE or COMMUNITY may not have greater-than-MOMENTARY CONTROL of more than 1 GAME PIECE, either directly or transitively through other objects.

A ROBOT is in CONTROL of a GAME PIECE if:

- A. the GAME PIECE is fully supported by the ROBOT, or
- B. the ROBOT is intentionally moving a GAME PIECE to a desired location or in a preferred direction

*Violation: FOUL per additional GAME PIECES. If egregious, YELLOW CARD.*

Moving a GAME PIECE to access an area of the FIELD (e.g. the CHARGE STATION) is not considered intentionally moving to a desired location or in a preferred direction.

Egregious examples include but are not limited to the following:

- a. simultaneous CONTROL of 3 GAME PIECES
- b. CONTINUOUS CONTROL of 2 or more GAME PIECES
- c. frequent CONTROL of 2 or more GAME PIECES (an approximate count for frequent in this context is if this rule is violated more than 3 times in a MATCH)

**G404 Launching GAME PIECES is only okay in the COMMUNITY.** A ROBOT may not launch GAME PIECES unless any part of the ROBOT is in its own COMMUNITY.

*Violation: TECH FOUL per GAME PIECE. REPEATED violations of this rule are likely to escalate rapidly to YELLOW or RED CARDS.*

A GAME PIECE is considered launched if it is shot into the air, kicked across the floor, or thrown in a forceful way.

This rule is not intended to penalize typical movement of GAME PIECES outside an ALLIANCE'S COMMUNITY which come to rest a short distance from the ROBOT. Examples of such actions could be but are not limited to,

- a. Running an intake in reverse causing a GAME PIECE to travel a short distance from the ROBOT
- b. A ROBOT pushing a GAME PIECE a short distance away in the process of herding it across the FIELD

**G405 Don't mess with the opponents' GRIDS.** A ROBOT may not move a scored GAME PIECE from an opponent's NODE.

*Violation: FOUL and opponents are awarded the SUSTAINABILITY BONUS Ranking Point.*



## 8 GAME RULES: HUMANS

FIRST is committed to [Equity, Diversity, and Inclusion](#) and as such, FIRST makes reasonable accommodations for persons with disabilities that request accommodation. If a participant needs an accommodation for an event, please talk to a volunteer at the event or contact local leadership before the event so they can help ensure the accommodation is provided.

Accommodations are adjustments that allow all people with disabilities to access the building and participate in the game. Accommodations are determined reasonable given they do not create an undue hardship or cause safety concerns.

### 8.1 General

**H101 \*Be a good person.** All teams must be civil toward everyone and respectful of team and event equipment while at a FIRST Robotics Competition event.

*Violation: Behavior will be discussed with team or individual. Violations of this rule are likely to escalate to YELLOW or RED CARDS rapidly (i.e. the threshold for egregious violations is relatively low.)*

Examples of inappropriate behavior include, but are not limited to use of offensive language or other uncivil conduct.

Examples of particularly contemptible behavior that is likely to result in ARENA ejection include, but are not limited to, the following:

- assault, e.g. throwing something that hits another person (even if unintended),
- threat, e.g. saying something like “if you don’t reverse that call, I’ll make you regret it,”
- harassment, e.g. badgering someone with no new information after a decision’s been made or a question’s been answered,
- bullying, e.g. using body or verbal language to cause another person to feel inadequate,
- insulting, e.g. telling someone they don’t deserve to be on a DRIVE TEAM,
- swearing *at* another person (versus swearing under one’s breath or at oneself), and
- yelling at another person(s) in anger or frustration.

**H102 \*Enter only 1 ROBOT.** Each registered FIRST Robotics Competition team may enter only 1 ROBOT (or “robot,” a ROBOT -like assembly equipped with most of its drive base, i.e. its MAJOR MECHANISM that enables it to move around a FIELD) into a 2023 FIRST Robotics Competition Event.

“Entering” a ROBOT (or robot) into a FIRST Robotics Competition means bringing it to or using it at the event such that it’s an aid to your team (e.g. for spare parts, judging material, or for practice).

While “most of its drive base” is a subjective assessment, for the purposes of this rule, an assembly whose drive base is missing all wheels/treads, gearboxes, and belts/chains is not considered a “robot.” If any of those COMPONENTS are incorporated, the assembly is now considered a “robot.”



This rule does not prohibit teams from bringing in robots from other *FIRST* programs for the purposes of awards presentations or pit displays.

*Violation: Verbal warning. Egregious or subsequent violations at any point during the event will be addressed by the Head REFEREE, the Lead ROBOT INSPECTOR (LRI), and/or Event Management.*

**H103 \*Humans, stay off the FIELD until green.** Team members may only enter the FIELD if the DRIVER STATION LED strings are green, unless explicitly instructed by a REFEREE or an FTA.

*Violation: Verbal warning. If subsequent violations at any point during the event, YELLOW CARD.*

Egregious violations of this rule to which [H201](#) may apply include, but are not limited to:

- a. pushing past the FIELD reset person blocking an open gate to get on the FIELD,
- b. ignoring a warning to not go on the FIELD,
- c. walking on to the FIELD during a MATCH, and
- d. reaching into the FIELD and grabbing a ROBOT during a MATCH.

Violations of this rule apply to the entire team, not specifically to any 1 individual. For example, a member of Team 9999 enters the FIELD prior to lights going green after MATCH 3, and a different member enters the FIELD prior to lights going green after MATCH 25. The team receives a verbal warning for the first violation and a YELLOW CARD for the second.

**H104 \*Never step over the guardrail.** Team members may only enter or exit the FIELD through open gates.

*Violation: Verbal warning. If subsequent violations at any point during the event, YELLOW CARD.*

Teams are encouraged to ensure that all members of their DRIVE TEAM are aware of this rule. It's easy to violate, particularly when teams are doing their best to move on and off the FIELD quickly. The violations of this rule are intended to avoid nuisance penalties, but still enforce safety requirements around the FIELD. There is the potential for injury when stepping over the guardrail.

Violations of this rule apply to the entire team, not specifically to any 1 individual. For example, a member of Team 9999 steps over the guardrail prior to MATCH 3, and a different member steps over the guardrail prior to MATCH 25. The team receives a verbal warning for the first violation and a YELLOW CARD for the second.

**H105 \*Asking other teams to throw a MATCH – not cool.** A team may not encourage an ALLIANCE, of which it is not a member, to play beneath its ability.

NOTE: This rule is not intended to prevent an ALLIANCE from planning and/or executing its own strategy in a specific MATCH in which all the teams are members of the ALLIANCE.

*Violation: Behavior will be discussed with team or individual. Violations of this rule are likely to escalate rapidly to YELLOW or RED CARDS and may lead to dismissal from the event (i.e. the threshold for egregious violations is relatively low.)*

Example 1: A MATCH is being played by Teams A, B, and C, in which Team C is encouraged by Team D to not ENGAGE at the end of the MATCH, resulting in Teams A, B, and C not earning a Ranking Point. Team D's motivation for this behavior is to prevent Team A from rising in the Tournament rankings and negatively affecting Team D's ranking. Team D has violated this rule.

Example 2: A MATCH is being played by Teams A, B, and C, in which Team A is assigned to participate as a SURROGATE. Team D encourages Team A to not participate in the MATCH so that Team D gains ranking position over Teams B and C. Team D has violated this rule.

*FIRST* considers the action of a team influencing another team to throw a MATCH, to deliberately miss Ranking Points, etc. incompatible with *FIRST* values and not a strategy any team should employ.

- H106** \***Letting someone coerce you in to throwing a MATCH – also not cool.** A team, as the result of encouragement by a team not on their ALLIANCE, may not play beneath its ability.

NOTE: This rule is not intended to prevent an ALLIANCE from planning and/or executing its own strategy in a specific MATCH in which all the ALLIANCE members are participants.

*Violation: Behavior will be discussed with team or individual. Violations of this rule are likely to escalate rapidly to YELLOW or RED CARDS and may lead to dismissal from the event (i.e. the threshold for egregious violations is relatively low.)*

Example 1: A MATCH is being played by Teams A, B, and C. Team D requests Team C ignore the CHARGE STATION at the end of the MATCH, resulting in Teams A, B, and C not being able to earn the ACTIVATION BONUS. Team C accepts this request from Team D. Team D's motivation for this behavior is to prevent Team A from rising in the Tournament rankings negatively affecting Team D's ranking. Team C has violated this rule.

Example 2: A MATCH is being played by Teams A, B, and C, in which Team A is assigned to participate as a SURROGATE. Team A accepts Team D's request to not participate in the MATCH so that Team D gains ranking position over Teams B and C. Team A has violated this rule.

*FIRST* considers the action of a team influencing another team to throw a MATCH, to deliberately miss Ranking Points, etc. incompatible with *FIRST* values and not a strategy any team should employ.

- H107** \***Throwing your own MATCH is bad.** A team may not intentionally lose a MATCH or sacrifice ranking points in an effort to lower their own ranking or manipulate the rankings of other teams.

*Violation: Behavior will be discussed with team or individual. Violations of this rule are likely to escalate rapidly to YELLOW or RED CARDS and may lead to dismissal from the event (i.e. the threshold for egregious violations is relatively low.)*

The intent of this rule is not to punish teams who are employing alternate strategies, but rather to ensure that it is clear that throwing MATCHES to negatively affect your own rankings, or to manipulate the rankings of other teams (i.e. throw a MATCH to lower a partner's ranking, and/or increase the ranking of another team not in the MATCH) is incompatible with *FIRST* values and not a strategy any team should employ.

- H108** \***Don't abuse ARENA access.** Team members (except DRIVERS, HUMAN PLAYERS, and COACHES) granted access to restricted areas in and around the ARENA (e.g. via TECHNICIAN button, event issued Media badges, etc.) may not assist or use signaling devices during the MATCH. Exceptions will be granted for inconsequential infractions and in cases concerning safety.

*Violation: YELLOW CARD.*

The TECHNICIAN'S role is to help the team prepare the ROBOT so it can perform at its full potential during a MATCH. The TECHNICIAN, except as described at the end of DRIVE TEAM, is not an additional COACH, DRIVER, or HUMAN PLAYER.

Team members in open-access spectator seating areas are not considered to be in a restricted area and are not prevented from assisting or using signaling devices. See [E102](#) for related details.

**H109** \***Be careful what you interact with.** Team members are prohibited from the following actions with regards to interaction with ARENA elements. Temporary deformation of a GAME PIECE (e.g. to pre-load a ROBOT) is an exception to this rule.

- A. climbing on or inside,
- B. hanging from,
- C. deforming, and
- D. damaging.

*Violation: Verbal warning. If subsequent violations at any point during the event, YELLOW CARD.*

**H110** **Don't mess with GAME PIECES.** Teams may not modify GAME PIECES in any way. Temporary deformation (e.g. to pre-load a ROBOT) is an exception to this rule.

*Violation: Verbal warning. If subsequent violations at any point during the event, YELLOW CARD.*

Marking or standing on GAME PIECES are examples of violations. Egregious violations of [H109](#) or [H110](#), such as cutting or intentionally deflating GAME PIECES, are subject to [H201](#).

## 8.2 REFEREE Interaction

**H201** \***Egregious or exceptional violations.** Egregious behavior beyond what is listed in the rules or subsequent violations of any rule or procedure during the event is prohibited.

In addition to rule violations explicitly listed in this manual and witnessed by a REFEREE, the Head REFEREE may assign a YELLOW or RED CARD for egregious ROBOT actions or team member behavior at any time during the event. This includes violations of the event rules found on the [FIRST® Robotics Competition District & Regional Events page](#).

Please see [Section 11.2.2 YELLOW and RED CARDS](#) for additional detail.

*Violation: The Head REFEREE may assign a YELLOW or a RED CARD.*

The intent of this rule is to provide the Head REFEREES the flexibility necessary to keep the event running smoothly, as well as keep the safety of all the participants as the highest priority. There are certain behaviors that automatically result in a YELLOW or RED CARD because this behavior puts the FIRST community at risk. Those behaviors include, but are not limited to the list below:

- a. inappropriate behavior as outlined in the blue box of [H101](#),
- b. jumping over the guardrail,
- c. behaviors listed in the blue box in [H103](#),
- d. PINNING in excess of 15 seconds,
- e. exploiting the 3-second scoring assessment period after a MATCH to avoid rule violations (e.g. triggering an over-extension that enables GRID points or using a ROBOT'S residual energy to impact an opponent ROBOT on their CHARGE STATION).

The Head REFEREE may assign a YELLOW or RED CARD for a single instance of a rule violation such as the examples given in items a-**Error! Reference source not found.** above, or for multiple instances of any single rule violation. Teams should be aware that any rule in this manual could escalate to a YELLOW or RED CARD. The Head REFEREE has final authority on all rules and violations at an event.

**H202 \*1 STUDENT, 1 Head REFEREE.** A team may only address the Head REFEREE with 1 STUDENT. The STUDENT may not be accompanied by more than 1 silent observer.

*Violation: The Head REFEREE will not address additional, non-compliant team members or peripheral conversations.*

Please see [Section 11.2 Head REFEREE and FTA Interaction](#) for more information about process and expectations. Note that some events may restrict ARENA access to members of the DRIVE TEAM.

### 8.3 Before/After the MATCH

**H301 \*Be prompt.** DRIVE TEAMS may not cause significant delays to the start of a MATCH. Causing a significant delay requires both of the following to be true:

A. The expected MATCH start time has passed, and

Event volunteers communicate schedule delays with teams to the best of their ability. The Pit Display (which is typically located near the Pit Administration desk) shows any event timing delay. Announcements on the FIELD and in the pits also provide information on delays, and any team uncertain of when to queue for a MATCH should communicate with queuing volunteers.

During Qualification MATCHES, the expected start time of the MATCH is the time indicated on the MATCH schedule or ~4 minutes from the end of the previous MATCH (which is reflected on the schedule on the Pit Display), whichever is later.

During Playoff MATCHES, the expected start time of the MATCH is the time indicated on the MATCH schedule or 15 minutes from either ALLIANCE'S previous MATCH, whichever is later.

B. The DRIVE TEAM is neither MATCH ready nor making a good faith effort, as perceived by the Head REFEREE, to quickly become MATCH ready.

Teams that have violated [H305](#) or have 1 DRIVE TEAM member present and have informed event staff that their ROBOT will not be participating in the MATCH are considered MATCH ready and not in violation of this rule.

*Violation: Verbal warning, or if a subsequent violation within the tournament phase (i.e. Qualifications or Playoffs), TECH FOUL applied to their upcoming MATCH. If the DRIVE TEAM is not MATCH ready within 2 minutes of the verbal warning/TECH FOUL and the Head REFEREE perceives no good faith effort by the DRIVE TEAM to quickly become MATCH ready, DISABLED.*

The intent of this rule is to provide an equitable amount of time for both ALLIANCES to prepare for each MATCH and give DRIVE TEAMS grace given extenuating circumstances that causes them to be late.

Once a verbal warning/TECH FOUL is issued, the Head REFEREE starts a 2-minute timer and makes a good faith effort to share the timer's status with the delaying DRIVE TEAM.

Being “MATCH ready” requires that the ROBOT is on the FIELD, in its STARTING CONFIGURATION, and turned on. Additionally, the DRIVE TEAM members must be in their starting positions.

In general, good faith efforts to quickly become MATCH ready are entirely for the purposes of transitioning the ROBOT into a MATCH ready state (i.e. not attempts to significantly alter a ROBOT’s capabilities.) Examples of good faith efforts to quickly become MATCH ready include but are not limited to:

- a. walking safely towards the FIELD with a ROBOT that a team is not actively modifying,
- b. applying quick fixes such as tape or cable ties to make the ROBOT compliant with STARTING CONFIGURATION requirements,
- c. waiting for an OPERATOR CONSOLE computer to boot, and
- d. working with FIELD STAFF to get the ROBOT connected to the FIELD.

Examples that are not considered good faith efforts to quickly become MATCH ready include but are not limited to:

- e. a ROBOT not moving to the FIELD,
- f. a ROBOT moving to the FIELD but being actively modified while doing so,
- g. a DRIVE TEAM member remaining on the FIELD once a MATCH is ready to begin (indicated by the green LEDs having turned off),
- h. installing BUMPERS, charging pneumatic systems, or any other ROBOT maintenance not considered a quick fix as described in item b above once on the FIELD, and
- i. time-consuming use of alignment devices that are external to the ROBOT (e.g. a DRIVE TEAM could bring and use a measuring tape, as long as there is no delay to the MATCH by doing so)

There are no rules that prohibit use of hand tools (including battery operated tools) while setting up ROBOTS from the FIELD, provided they do not cause significant delay or cause safety concerns.

**H302 \*Teams may not enable their ROBOTS on the FIELD.** Teams may not tether to the ROBOT while on the FIELD except in special circumstances (e.g. after Opening Ceremonies, before an immediate MATCH replay, etc.) and with the express permission from the FTA or a REFEREE.

*Violation: YELLOW CARD*

Teams are encouraged to consider this rule when developing their ROBOTS.

FMS will not enable ROBOTS after the conclusion of the MATCH.

Tethering includes any wired or wireless connection used to electrically energize and/or control elements on the ROBOT. The safety of teams and volunteers in close proximity to ROBOTS and ARENA elements on the FIELD is of the utmost importance, therefore ROBOTS or ROBOT COMPONENTS may not be enabled in any way on the FIELD before or after the MATCH.

ROBOTS need to be safely transported off the FIELD and back to the pits after the MATCH, and there may be bystanders, doorways, or height restrictions along the route.

**H303 \*You can’t bring/use anything you want.** The only equipment that may be brought to the ARENA and used by DRIVE TEAMS during a MATCH is listed below. Regardless of if equipment fits criteria below, it may not be employed in a way that breaks any other rules, introduces a safety



hazard, blocks visibility for FIELD STAFF or audience members, or jams or interferes with the remote sensing capabilities of another team or the FIELD.

- A. the OPERATOR CONSOLE,
- B. non-powered signaling devices,
- C. reasonable decorative items,
- D. special clothing and/or equipment required due to a disability,
- E. devices used solely for planning or tracking strategy,
- F. devices used solely to record gameplay, and
- G. non-powered Personal Protective Equipment (examples include, but aren't limited to, gloves, eye protection, and hearing protection)

Items brought to the ARENA under allowances [B-G](#) must meet all following conditions:

- I. do not connect or attach to the OPERATOR CONSOLE, FIELD, or ARENA,
- II. do not connect or attach to another ALLIANCE member (other than items in category G),
- III. do not communicate with anything or anyone outside of the ARENA,
- IV. do not communicate with the TECHNICIAN,
- V. do not include any form of enabled wireless electronic communication with the exception of medically required equipment, and
- VI. do not in any way affect the outcome of a MATCH, other than by allowing the drive team to
  - a. plan or track strategy for the purposes of communication of that strategy to other ALLIANCE members or
  - b. use items allowed per [B](#) to communicate with the ROBOT.

*Violation: MATCH will not start until situation remedied. If discovered or used inappropriately during a MATCH, YELLOW CARD.*

Examples of equipment that may be considered a safety hazard in the confined space of the ALLIANCE AREA include, but are not limited to, a step stool or a large signaling device.

Examples of remote sensing capabilities include, but are not limited to, vision systems, acoustic range finders, sonars, and infrared proximity sensors.

Use of imagery that, to a reasonably astute observer, mimics the Vision Targets employed on the FIELD is a violation of this rule.

Examples of wireless communication include, but are not limited to, radios, walkie-talkies, cell phones, Bluetooth communications, and Wi-Fi.

**H304** **\*By invitation only.** Only DRIVE TEAMS for the current MATCH are allowed in their respective ALLIANCE AREAS and SUBSTATION AREAS.

*Violation: MATCH won't start until the situation is corrected.*

**H305** **\*Show up to your MATCHES.** Upon each team's ROBOT passing initial, complete inspection, the team must send at least 1 member of its DRIVE TEAM to the ARENA and participate in each of the team's assigned Qualification and Playoff MATCHES.

*Violation: RED CARD.*

Figure 8-1 MATCH participation flowchart

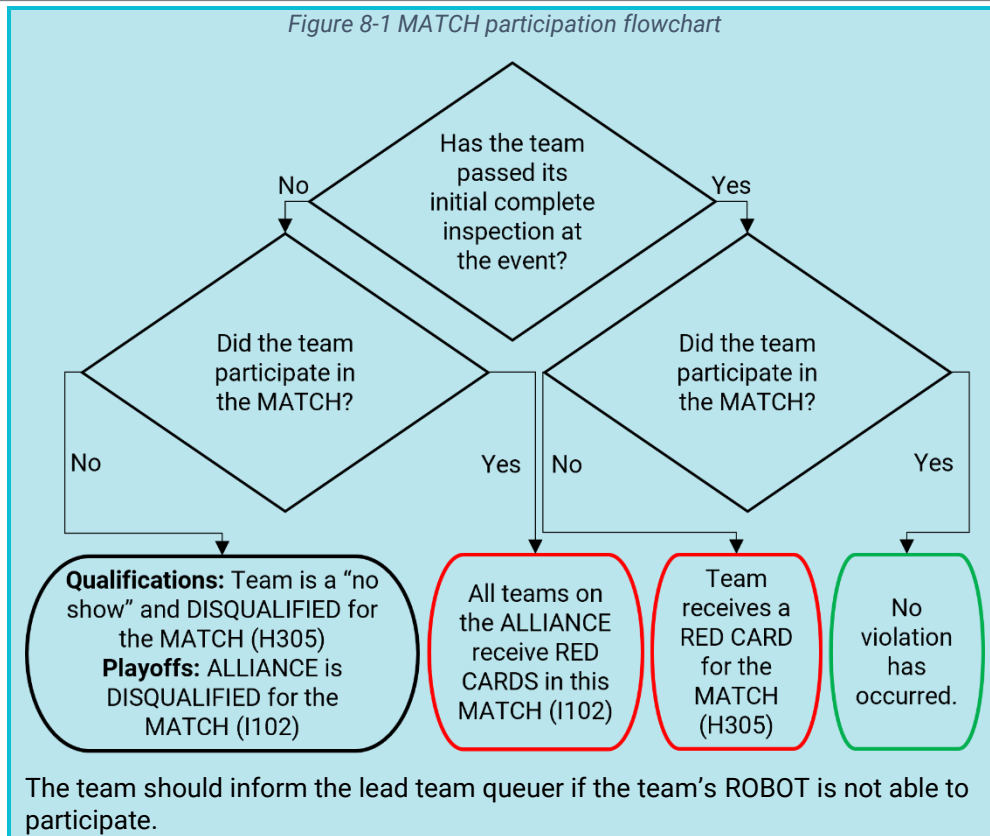

**H306 \*Identify yourself.** DRIVE TEAMS must wear proper identification while in the ARENA. Proper identification consists of:

- A. all DRIVE TEAM members wearing their designated buttons above the waist in a clear visible location at all times while in the ARENA
- B. the COACH wearing the "COACH" button
- C. the DRIVERS and HUMAN PLAYERS each wearing a "DRIVE TEAM" button
- D. the TECHNICIAN wearing the "TECHNICIAN" button
- E. during a Playoff MATCH, the ALLIANCE CAPTAIN clearly displaying the designated ALLIANCE CAPTAIN identifier (e.g. hat or armband)

*Violation: MATCH won't start until the situation is corrected. Those not displaying identification must leave the ARENA.*

**H307 \*Plug in to/be in your DRIVER STATION.** The OPERATOR CONSOLE must be used in the DRIVER STATION to which the team is assigned, as indicated on the team sign.

*Violation: MATCH won't start until the situation is corrected. If during a MATCH, DISABLED.*

An intent of this rule is to prevent unsafe situations where long tethers to OPERATOR CONSOLE devices increase tripping hazards as the operator moves about the ALLIANCE AREA. In the interest of avoiding nuisance penalties associated with a DRIVE TEAM member stepping outside of a prescribed area, we prefer to offer a general guideline as to what it means to use the OPERATOR CONSOLE in the ALLIANCE AREA. Provided the DRIVE TEAM member is within close proximity of their DRIVER STATION, there will be no repercussions. However, a DRIVE TEAM member located more than approximately half a

DRIVER STATION width away from their own DRIVER STATION while using their OPERATOR CONSOLE is likely violating this rule.

**H308 \*Don't bang on the glass.** Team members may never strike or hit the DRIVER STATION plastic windows.

*Violation: Verbal warning. If subsequent violations in more than 1 MATCH, YELLOW CARD.*

**H309 Know your ROBOT setup.** When placed on the FIELD for a MATCH, each ROBOT must be:

- A. in compliance with all ROBOT rules, i.e. has passed inspection (for exceptions regarding Practice MATCHES, see [Section 10 Inspection & Eligibility Rules](#)),
- B. the only team-provided item left on the FIELD by the DRIVE TEAM,
- C. confined to its STARTING CONFIGURATION (reference [R102](#) and [R104](#)),
- D. positioned such that it is fully contained within its COMMUNITY
- E. not in contact with the CHARGE STATION
- F. fully supported by FIELD carpet, and
- G. fully and solely supporting not more than 1 GAME PIECE (as described in [Section 6.1 Setup](#)).

*Violation: If fix is a quick remedy, the MATCH won't start until all requirements are met. If it is not a quick remedy, the offending ROBOT will be DISABLED and, at the discretion of the Head REFEREE, must be re-inspected.*

If a ROBOT is BYPASSED prior to the start of the MATCH, the DRIVE TEAM may not remove the ROBOT from the FIELD without permission from the Head REFEREE or the FTA.

**H310 Know your DRIVE TEAM positions.** Prior to the start of the MATCH, DRIVE TEAM members must be positioned as follows:

- A. DRIVERS: inside their ALLIANCE AREA and behind the STARTING LINE,
- B. COACHES: inside their ALLIANCE AREA and behind the STARTING LINE, and
- C. HUMAN PLAYERS:
  - a. at least one HUMAN PLAYER in their SUBSTATION AREA,
  - b. any remaining HUMAN PLAYERS: inside their ALLIANCE AREA and behind the STARTING LINE, and
- D. TECHNICIANS: in the event-designated area near the FIELD.

*Violation: MATCH won't start until the situation is corrected.*

**H311 Leave the GAME PIECES alone.** Prior to the start of the MATCH, HUMAN PLAYERS may not rearrange the GAME PIECES within the SUBSTATION AREA.

*Violation: MATCH won't start until the situation is corrected.*

## 8.4 During the MATCH: AUTO

**H401 \*Behind the lines.** During AUTO, DRIVE TEAM members in ALLIANCE AREAS and HUMAN PLAYERS in their SUBSTATION AREAS may not contact anything in front of the STARTING LINES, unless for personal or equipment safety or granted permission by a Head REFEREE or FTA.

*Violation: FOUL per item contacted.*

Pointing, gesturing, or otherwise extending across the STARTING LINE such that contact is not made with carpet or other ARENA elements is not a violation of this rule.

An example of an exception for equipment safety is if an OPERATOR CONSOLE starts to fall from, or has already fallen off of, the DRIVER STATION shelf. In that circumstance, DRIVE TEAM members may step forward to catch it or pick it up off the ground and return it to the shelf.

- H402** \***Disconnect or set down controllers.** Prior to the start of the MATCH, any control devices worn or held by HUMAN PLAYERS and/or DRIVERS must be disconnected from the OPERATOR CONSOLE.

*Violation: MATCH won't start until the situation is corrected.*

For the purposes of FIRST Robotics Competition, any device connected to the OPERATOR CONSOLE is considered a control device because REFEREES are not expected to differentiate between devices that can or cannot control the ROBOT.

- H403** \***Let the ROBOT do its thing.** During AUTO, DRIVE TEAMS may not directly or indirectly interact with ROBOTS or OPERATOR CONSOLES unless for personal safety, OPERATOR CONSOLE safety, or pressing an E-Stop.

*Violation: FOUL and YELLOW CARD*

## 8.5 During the MATCH

- H501** \***COACHES and other teams: hands off the controls.** A ROBOT shall be operated only by the DRIVERS and/or HUMAN PLAYERS of that team.

*Violation: DISABLED.*

Exceptions may be made before a MATCH for major conflicts, e.g. religious holidays, major testing, transportations issues, etc.

- H502** \***No wandering.** DRIVE TEAMS may not contact anything outside the area in which they started the MATCH (i.e. the ALLIANCE AREA, the SUBSTATION AREA, or the designated TECHNICIAN space). Exceptions are granted in cases concerning safety and for actions that are inadvertent, MOMENTARY, and inconsequential.

*Violation: FOUL.*

- H503** \***COACHES, GAME PIECES are off limits.** COACHES may not touch GAME PIECES, unless for safety purposes.

*Violation: FOUL per GAME PIECE.*

- H504** **GAME PIECES through PORTALS only.** GAME PIECES may only be introduced to the FIELD

- A. by a HUMAN PLAYER,
- B. through a PORTAL, and
- C. during TELEOP.

*Violation: FOUL per GAME PIECES.*

- H505** **DRIVE TEAMS, watch your reach.** DRIVE TEAMS may not extend any body part into the SINGLE SUBSTATION PORTAL for a greater-than-MOMENTARY period of time.

---

Violation: FOUL.





## 9 ROBOT CONSTRUCTION RULES

The rules listed below explicitly address legal parts and materials and how those parts and materials may be used on a CHARGED UP ROBOT. A ROBOT is an electromechanical assembly built by the *FIRST* Robotics Competition team to play the current season’s game and includes all the basic systems required to be an active participant in the game –power, communications, control, BUMPERS, and movement about the FIELD. A BUMPER is a protective assembly designed to attach to the exterior of the ROBOT and constructed as specified in [Section 9.4 BUMPER Rules](#).

There are many reasons for the structure of the rules, including safety, reliability, parity, creation of a reasonable design challenge, adherence to professional standards, impact on the competition, and compatibility with the [Kit of Parts \(KOP\)](#). The KOP is the collection of items listed on the current season’s Kickoff Kit Checklists, distributed to the team via *FIRST* Choice in the current season, or paid for completely (except shipping) with a Product Donation Voucher (PDV) from the current season.

Another intent of these rules is to have all energy sources and active actuation systems on the ROBOT (e.g. batteries, compressors, motors, servos, cylinders, and their controllers) drawn from a well-defined set of options. This is to ensure that all teams have access to the same actuation resources and that the INSPECTORS are able to accurately and efficiently assess the legality of a given part.

ROBOTS are made up of COMPONENTS and MECHANISMS. A COMPONENT is any part in its most basic configuration, which cannot be disassembled without damaging or destroying the part or altering its fundamental function. A MECHANISM is an assembly of COMPONENTS that provide specific functionality on the ROBOT. A MECHANISM can be disassembled (and then reassembled) into individual COMPONENTS without damage to the parts.

Many rules in this section reference Commercial-Off-The-Shelf (COTS) items. A COTS item must be a standard (i.e. not custom order) part commonly available from a VENDOR for all teams for purchase. To be a COTS item, the COMPONENT or MECHANISM must be in an unaltered, unmodified state (with the exception of installation or modification of any software). Items that are no longer commercially available but are functionally equivalent to the original condition as delivered from the VENDOR are considered COTS and may be used.

Example 1: A team orders 2 ROBOT grippers from RoboHands Corp. and receives both items. They put 1 in their storeroom and plan to use it later. Into the other, they drill “lightening holes” to reduce weight. The first gripper is still classified as a COTS item, but the second gripper is now a FABRICATED ITEM, as it has been modified.

Example 2: A team obtains openly available blueprints of a drive module commonly available from Wheels-R-Us Inc. and has local machine shop “We-Make-It, Inc.” manufacture a copy of the part for them. The produced part is not a COTS item, because it is not commonly carried as part of the standard stock of We-Make-It, Inc.

Example 3: A team obtains openly available design drawings from a professional publication during the pre-season and uses them to fabricate a gearbox for their ROBOT during the build period following Kickoff. The design drawings are considered a COTS item and may be used as “raw material” to fabricate the gearbox. The finished gearbox itself would be a FABRICATED ITEM, and not a COTS item.

Example 4: A COTS part that has non-functional label markings added would still be considered a COTS part, but a COTS part that has device-specific mounting holes added is a FABRICATED ITEM.

Example 5: A team has a COTS single-board processor version 1.0, which can no longer be purchased. Only the COTS single-board processor version 2.0 may be purchased. If the COTS single-board processor version 1.0 is functionally equivalent to its original condition, it may be used.

Example 6: A team has a COTS gearbox which has been discontinued. If the COTS gearbox is functionally equivalent to its original condition, it may be used.

A **VENDOR** is a legitimate business source for COTS items that satisfies all the following criteria:

- A. has a Federal Tax Identification number. In cases where the **VENDOR** is outside of the United States, they must possess an equivalent form of registration or license with the government of their home nation that establishes and validates their status as a legitimate business licensed to operate within that country.
- B. is not a “wholly owned subsidiary” of a *FIRST* Robotics Competition team or collection of teams. While there may be some individuals affiliated with both a team and the **VENDOR**, the business and activities of the team and **VENDOR** must be completely separable.
- C. must be able to ship any general (i.e., non-*FIRST* unique) product within 5 business days of receiving a valid purchase request. It is recognized that certain unusual circumstances (such as 1,000 *FIRST* teams all ordering the same part at once from the same **VENDOR**) may cause atypical delays in shipping due to backorders for even the largest **VENDORS**. Such delays due to higher-than-normal order rates are excused.
- D. should maintain sufficient stock or production capability to fill teams’ orders within a reasonable period during the season (less than 1 week). This criterion may not apply to custom-built items from a source that is both a **VENDOR** and a fabricator.

For example, a **VENDOR** may sell flexible belting that the team wishes to procure to use as treads on their drive system. The **VENDOR** cuts the belting to a custom length from standard shelf stock that is typically available, welds it into a loop to make a tread, and ships it to a team. The fabrication of the tread takes the **VENDOR** 2 weeks. This would be considered a FABRICATED ITEM, and the 2-week ship time is acceptable. Alternately, the team may decide to fabricate the treads themselves. To satisfy this criterion, the **VENDOR** would just have to ship a length of belting from shelf stock (i.e. a COTS item) to the team within 5 business days and leave the welding of the cuts to the team.

- E. makes their products available to all *FIRST* Robotics Competition teams. A **VENDOR** must not limit supply or make a product available to just a limited number of *FIRST* Robotics Competition teams.

The intent of this definition is to be as inclusive as possible to permit access to all legitimate sources, while preventing ad hoc organizations from providing special-purpose products to a limited subset of teams in an attempt to circumvent the cost accounting rules.

*FIRST* desires to permit teams to have the broadest choice of legitimate sources possible, and to obtain COTS items from the sources that provide them with the best prices and level of service available. Teams also need to protect against long delays in availability of parts that will impact their ability to complete their **ROBOT**. The build season is brief, so the **VENDOR** must be able to get their product, particularly *FIRST* unique items, to a team in a timely manner.

Ideally, chosen VENDORS should have national distributors (e.g. Home Depot, Lowes, MSC, McMaster-Carr, etc.). Remember, *FIRST* Robotics Competition events are not always near home – when parts fail, local access to replacement materials is often critical.

A FABRICATED ITEM is any COMPONENT or MECHANISM that has been altered, built, cast, constructed, concocted, created, cut, heat treated, machined, manufactured, modified, painted, produced, surface coated, or conjured partially or completely into the final form in which it will be used on the ROBOT.

Note that it is possible for an item (typically raw materials) to be neither COTS nor a FABRICATED ITEM. For example, a 20 ft. (~610 cm) length of aluminum which has been cut into 5 ft. (~152 cm) pieces by the team for storage or transport is neither COTS (it's not in the state received from the VENDOR), nor a FABRICATED ITEM (the cuts were not made to advance the part towards its final form on the ROBOT).

Teams may be asked to provide documentation proving legality of non-CHARGED UP KOP items during inspection where a rule specifies limits for a legal part (e.g. pneumatic items, current limits, COTS electronics, etc.).

Some of these rules make use of English unit requirements for parts. If your team has a question about a metric-equivalent part's legality, please e-mail your question to the *FIRST* Robotics Competition Kit of Parts team at [frcparts@firstinspires.org](mailto:frcparts@firstinspires.org) for an official ruling. To seek approval for alternate devices for inclusion in future *FIRST* Robotics Competition seasons, please contact the Kit of Parts team at [frcparts@firstinspires.org](mailto:frcparts@firstinspires.org) with item specifications.

Teams should acknowledge the support provided by the corporate sponsors and mentors with an appropriate display of their school and sponsors names and/or logos (or the name of the supporting youth organization, if appropriate).

*FIRST* Robotics Competition can be a full-contact competition and may include rigorous game play. While the rules aim to limit severe damage to ROBOTS, teams should design their ROBOTS to be robust.

## 9.1 General ROBOT Design

**R101** \*FRAME PERIMETER must be fixed. The ROBOT (excluding BUMPERS) must have a FRAME PERIMETER, contained within the BUMPER ZONE and established while in the ROBOT'S STARTING CONFIGURATION, that is comprised of fixed, non-articulated structural elements of the ROBOT. Minor protrusions no greater than ¼ in. (~6 mm) such as bolt heads, fastener ends, weld beads, and rivets are not considered part of the FRAME PERIMETER.

To determine the FRAME PERIMETER, wrap a piece of string around the ROBOT (excluding BUMPERS) at the BUMPER ZONE described in [R402](#) and pull it taut. The string outlines the FRAME PERIMETER.

Example: A ROBOT'S chassis is shaped like the letter 'V', with a large gap between chassis elements on the front of the ROBOT. When wrapping a taut string around this chassis, the string extends across the gap and the resulting FRAME PERIMETER is a triangle with 3 sides.

Figure 9-1 FRAME PERIMETER example

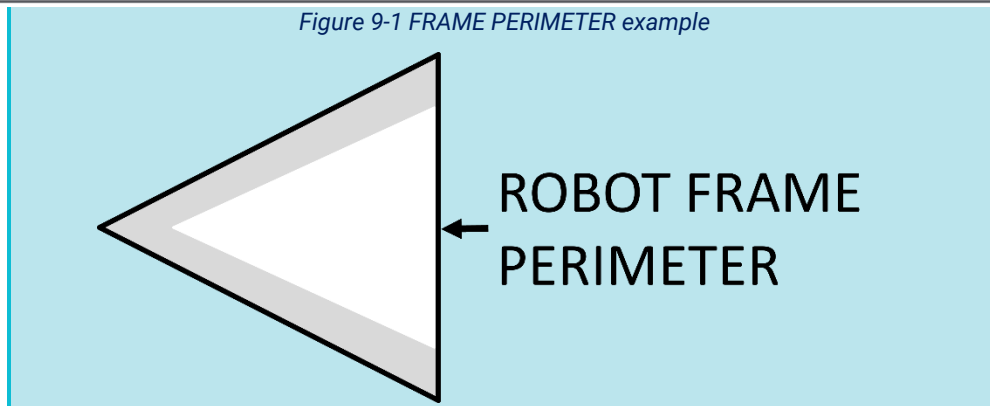

- R102 \*STARTING CONFIGURATION – no overhang.** In the STARTING CONFIGURATION (the physical configuration in which a ROBOT starts a MATCH), no part of the ROBOT shall extend outside the vertical projection of the FRAME PERIMETER, with the exception of its BUMPERS and minor protrusions such as bolt heads, fastener ends, rivets, cable ties, etc.

If a ROBOT is designed as intended and each side is pushed up against a vertical wall (in STARTING CONFIGURATION and with BUMPERS removed), only the FRAME PERIMETER (or minor protrusions) will be in contact with the wall.

The allowance for minor protrusions in this rule is intended to allow protrusions that are both minor in extension from the FRAME PERIMETER and cross-sectional area.

If a ROBOT uses interchangeable MECHANISMS per [I103](#), Teams should be prepared to show compliance with this rule and [R105](#) in all configurations.

- R103 \*ROBOT weight limit.** The ROBOT weight must not exceed 125 lbs. (~56 kg). When determining weight, the basic ROBOT structure and all elements of all additional MECHANISMS that might be used in a single configuration of the ROBOT shall be weighed together (see [I103](#)).

For the purposes of determining compliance with the weight limitations, the following items are excluded:

- A. ROBOT BUMPERS,
- B. ROBOT battery and its associated half of the Anderson cable quick connect/disconnect pair (including no more than 12 in. (~30 cm) of cable per leg, the associated cable lugs, connecting bolts, and insulation), and
- C. tags used for location detection systems if provided by the event.

- R104 STARTING CONFIGURATION – max size.** A ROBOT'S STARTING CONFIGURATION may not have a FRAME PERIMETER greater than 120 in. (~304 cm) and may not be more than 4 ft. 6 in. (~137 cm) tall.

Be sure to consider the size of the ROBOT on its cart to make sure it will fit through doors. Also consider the size of the ROBOT to ensure that it will fit into a shipping crate, vehicle, etc.

Note that rules contained in [Section 9.4 BUMPER Rules](#) may impose additional restrictions on ROBOT design.

**R105** **ROBOT extension limit.** ROBOTS may not extend more than 48 in. (~121 cm) beyond their FRAME PERIMETER.

Figure 9-2 FRAME PERIMETER extension

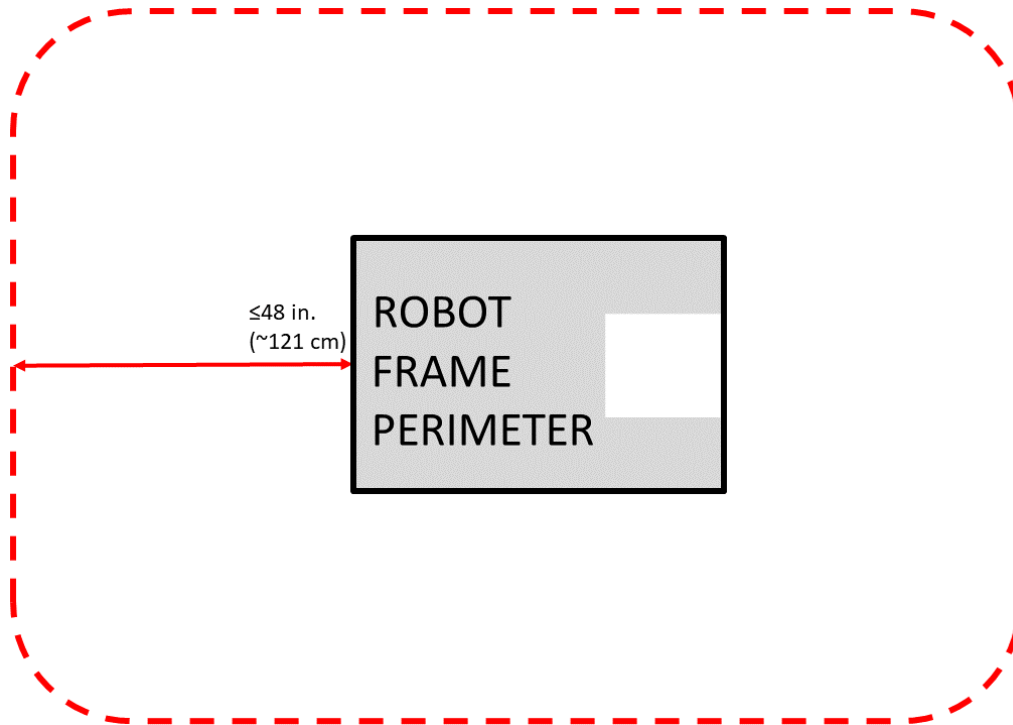

Teams should expect to have to demonstrate a ROBOT'S ability to constrain itself per above during inspection. Constraints may be implemented with either hardware or software.

See [Section 7 Game Rules: ROBOTS](#) for height and extension restrictions for various areas of the FIELD.

## 9.2 ROBOT Safety & Damage Prevention

- R201** **\*No digging into carpet.** Traction devices must not have surface features that could damage the ARENA (e.g. metal, sandpaper, hard plastic studs, cleats, hook-loop fasteners or similar attachments). Traction devices include all parts of the ROBOT that are designed to transmit any propulsive and/or braking forces between the ROBOT and FIELD carpet.
- R202** **\*No exposed sharp edges.** Protrusions from the ROBOT and exposed surfaces on the ROBOT shall not pose hazards to the ARENA elements (including GAME PIECES) or people.
- R203** **\*General safety.** ROBOT parts shall not be made from hazardous materials, be unsafe, cause an unsafe condition, or interfere with the operation of other ROBOTS.

Examples of items that will violate this rule include (but are not limited to):

- shields, curtains, or any other devices or materials designed or used to obstruct or limit the vision of any DRIVE TEAM members and/or interfere with their ability to safely control their ROBOT,
- speakers, sirens, air horns, or other audio devices that generate sound at a level sufficient to be a distraction,



- c. any devices or decorations specifically intended to jam or interfere with the remote sensing capabilities of another ROBOT, including vision systems, acoustic range finders, sonars, infrared proximity detectors, etc. (e.g. including imagery on your ROBOT that, to a reasonably astute observer, mimics the retro-reflective features of vision targets described in [Section 5.9 Vision Targets](#)),
- d. exposed lasers other than Class I,
- e. flammable gasses,
- f. any device intended to produce flames or pyrotechnics,
- g. hydraulic fluids or hydraulic items,
- h. switches or contacts containing liquid mercury,
- i. circuitry used to create voltages in excess of 24 Volts,
- j. any ballast not secured sufficiently, including loose ballast e.g. sand, ball bearings, etc., such that it may become loose during a MATCH,
- k. exposed, untreated hazardous materials (e.g. lead weights) used on the ROBOT. These materials may be permitted if painted, encapsulated, or otherwise sealed to prevent contact. These materials may not be machined in any way at an event.
- l. tire sealant, and
- m. high intensity light sources used on the ROBOT (e.g. super bright LED sources marketed as 'military grade' or 'self-defense') may only be illuminated for a brief time while targeting and may need to be shrouded to prevent any exposure to participants. Complaints about the use of such light sources will be followed by re-inspection and possible disablement of the device.

**R204** \***GAME PIECES stays with the FIELD.** ROBOTS must allow removal of GAME PIECES from the ROBOT and the ROBOT from FIELD elements while DISABLED and powered off.

ROBOTS will not be re-enabled after the MATCH, so teams must be sure that GAME PIECES and ROBOTS can be quickly, simply, and safely removed.

Teams are encouraged to consider [H301](#) when developing their ROBOTS.

**R205** \***Don't contaminate the FIELD.** Lubricants may be used only to reduce friction within the ROBOT. Lubricants must not contaminate the FIELD or other ROBOTS.

**R206** \***Don't damage GAME PIECES.** ROBOT elements likely to come in contact with a GAME PIECE shall not pose a significant hazard to the GAME PIECE.

GAME PIECES are expected to undergo a reasonable amount of wear and tear as they are handled by ROBOTS, such as scratching or marking. Gouging, tearing off pieces, or routinely marking GAME PIECES are violations of this rule.

### 9.3 Budget Constraints & Fabrication Schedule

**R301** \***Individual item cost limit.** No individual, non-KOP item or software shall have a Fair Market Value (FMV) that exceeds \$600 USD. The total cost of COMPONENTS purchased in bulk may exceed \$600 USD as long as the cost of an individual COMPONENT does not exceed \$600 USD.

Teams should be ready to show INSPECTORS documentation of FMV for any COMPONENTS that appear to be in the range of the \$600 USD limit.

The Analog Devices IMU MXP Breakout Board, P/N ADIS16448, does not have a published FMV. This device is considered to comply with this rule regardless of its true FMV.

The FMV of a COTS item is its price defined by a VENDOR for the part or an identical functional replacement. This price must be generally available to all *FIRST* Robotics Competition teams throughout the build and competition season (i.e. short-term sale prices or coupons do not reflect FMV), however teams are only expected to make a good faith effort at determining the item price and are not expected to monitor prices of ROBOT items throughout the season. The FMV is the cost of the item itself and does not include any duties, taxes, tariffs, shipping, or other costs that may vary by locality.

The FMV of COTS software is the price, set by the VENDOR, to license the software (or piece of the software) that runs on the ROBOT for the period from Kickoff to the end of the *FIRST* Championship. The FMV of software licensed free-of-cost, including through the Virtual KOP, for use on the ROBOT is \$0.

The FMV of FABRICATED parts is the value of the material and/or labor, except for labor provided by team members (including sponsor employees who are members of the team), members of other teams, and/or event provided machine shops. Material costs are accounted for as the cost of any purchasable quantity that can be used to make the individual part (i.e. the purchasable raw material is larger than the FABRICATED part).

Example 1: A team orders a custom bracket made by a company to the team's specification. The company's material cost and normally charged labor rate apply.

Example 2: A team receives a donated sensor. The company would normally sell this item for \$450 USD, which is therefore its FMV.

Example 3: A team purchases titanium tube stock for \$400 USD and has it machined by a local machine shop. The machine shop is not considered a team sponsor but donates 2 hours of expended labor anyway. The team must include the estimated normal cost of the labor as if it were paid to the machine shop and add it to the \$400 USD.

Example 4: A team purchases titanium tube stock for \$400 USD and has it machined by a local machine shop that is a recognized sponsor of the team. If the machinists are considered members of the team, their labor costs do not apply. The total applicable cost for the part would be \$400 USD.

It is in the best interests of the teams and *FIRST* to form relationships with as many organizations as possible. Recognizing supporting companies as sponsors of, and members in, the team is encouraged, even if the involvement of the sponsor is solely through the donation of fabrication labor.

Example 5: A team purchases titanium tube stock for \$400 USD and has it machined by another team. The total applicable cost for the part would be \$400 USD.

Example 6: A team purchases a widget at a garage sale or online auction for \$300, but it's available for sale from a VENDOR for \$700. The FMV is \$700.

If a COTS item is part of a modular system that can be assembled in several possible configurations, then each individual module must fit within the price constraints defined in this rule.

If the modules are designed to assemble into a single configuration, and the assembly is functional in only that configuration, then the total cost of the complete assembly including all modules must fit within the price constraints defined in this rule.

In summary, if a VENDOR sells a system or a kit, a team must use the entire system/kit FMV and not the value of its COMPONENT pieces.

Example 7: VENDOR A sells a gearbox that can be used with a number of different gear sets, and can mate with 2 different motors they sell. A team purchases the gearbox, a gear set, and a motor, then assembles them together. Each part is treated separately for the purpose of determining FMV since the purchased pieces can each be used in various configurations.

Example 8: VENDOR B sells a robotic arm assembly that a team wants to use. However, it costs \$630 USD, so they cannot use it. The VENDOR sells the “hand”, “wrist”, and “arm” as separate assemblies, for \$210 USD each. A team wishes to purchase the 3 items separately, then reassemble them. This would not be legal, as they are really buying and using the entire assembly, which has a Fair Market Value of \$630 USD.

Example 9: VENDOR C sells a set of wheels or wheel modules that are often used in groups of 4. The wheels or modules can be used in other quantities or configurations. A team purchases 4 and uses them in the most common configuration. Each part is treated separately for the purpose of determining FMV, since the purchased pieces can be used in various configurations.

**R302** \*Custom parts, generally from this year only. FABRICATED ITEMS created before Kickoff are not permitted. Exceptions are:

- A. OPERATOR CONSOLE,
- B. BUMPERS,
- C. battery assemblies as described in [R103-B](#),
- D. FABRICATED ITEMS consisting of 1 COTS electrical device (e.g. a motor or motor controller) and attached COMPONENTS associated with any of the following modifications:
  - a. wires modified to facilitate connection to a ROBOT (including removal of existing connectors),
  - b. connectors and any materials to secure and insulate those connectors added (note: passive PCBs such as those used to adapt motor terminals to connectors are considered connectors),
  - c. motor shafts modified and/or gears, pulleys, or sprockets added, and
  - d. motors modified with a filtering capacitor as described in the blue box below [R625](#).
- E. COTS items, or functional equivalents, with any of the following modifications:
  - a. non-functional decoration or labeling,
  - b. assembly of COTS items per manufacturer specs, unless the result constitutes a MAJOR MECHANISM as defined in [I101](#), and
  - c. work that could be reasonably accomplished in fewer than 30 minutes with the use of handheld tools (e.g. drilling a small number of holes in a COTS part).

Please note that this means FABRICATED ITEMS from ROBOTS entered in previous *FIRST* competitions may not be used on ROBOTS in the CHARGED UP *FIRST* Robotics Competition (other than those allowed per [R302-B](#) through [E](#)). Before the formal start of the build season, teams are encouraged to think as much as they please about their ROBOTS. They may develop prototypes, create proof-of-concept models, and conduct design exercises. Teams may gather all the raw stock materials and COTS COMPONENTS they want.

Functionally equivalent items are items that closely resemble a COTS item in both form and function. Functional equivalents should be made using similar materials to the COTS equivalents.

Parts with precision machined (mill, CNC, etc.) features may still meet part [E.c](#) of this rule if functionally equivalent features could reasonably be made within the restrictions specified.

Example 1: A team designs and builds a 2-speed shifting transmission during the fall as a training exercise. After Kickoff, they utilize all the design principles they learned in the fall to design their ROBOT. To optimize the transmission design for their ROBOT, they change the transmission gear ratios and reduce the size, and build 2 new transmissions, and place them on the ROBOT. All parts of this process are permitted activities.

Example 2: A team re-uses a CHARGED UP-legal motor from a previous ROBOT which has had connectors added to the wires. This is permitted, per exception [D](#), because the motor is a COTS electrical COMPONENT.

Example 3: A team re-uses a piece of aluminum tubing from a previous ROBOT which has a precision machined bearing hole in it. On the current ROBOT, the bearing hole is not used. As the only function of the hole on the current ROBOT is material removal, which does not require precise tolerancing, a functionally equivalent hole could be made with a hand drill in under 30 minutes and the part is permitted per part [E.c](#).

- R303** \*Create new designs and software, unless they're public. ROBOT software and designs created before Kickoff are only permitted if the source files (complete information sufficient to produce the design) are available publicly prior to Kickoff.

Example 1: A team realizes that the transmission designed and built in the fall perfectly fits their need for a transmission to drive the ROBOT arm. They build an exact copy of the transmission from the original design plans, and bolt it to the ROBOT. This would be prohibited, as the transmission – although made during the competition season – was built from detailed designs developed prior to Kickoff.

Example 2: A team developed an omni-directional drive system for the 2019 competition. In July 2019 they refined and improved the control software, written in C++, to add more precision and capabilities. They decided to use a similar system for the CHARGED UP competition. They copied large sections of unmodified code over into the control software of the new ROBOT, also written in C++. This would be a violation of the schedule constraint and is not allowed.

Example 3: The same team decides to use LabVIEW as their software environment for CHARGED UP. Following Kickoff, they use the previously developed C++ code as a reference for the algorithms and calculations required to implement their omni-directional control solution. Because they developed new LabVIEW code as they ported over their algorithms, this is permitted.

Example 4: A different team develops a similar solution during the fall and plans to use the developed software on their competition ROBOT. After completing the software, they post it in a generally accessible public forum and make the code available to all teams. Because they have made their software publicly available before Kickoff, they can use it on their ROBOT.

Example 5: A team develops a transmission prior to Kickoff. After completing the project, they publish the CAD files on a generally accessible public forum and

make them available to all teams. Because they have made the design publicly available before Kickoff, they can use the design to create an identical transmission, fabricated after Kickoff, for use on their CHARGED UP ROBOT.

**R304** \*During an event, only work during pit hours. During an event a team is attending (regardless of whether the team is physically at the event location), the team may neither work on nor practice with their ROBOT or ROBOT elements outside of the hours that pits are open, with the following exceptions:

- A. exceptions listed in [R302](#), other than [R302-E-c](#),
- B. software development, and
- C. charging batteries.

For the purposes of this rule, official events begin as follows:

- Regionals, District Championships, and *FIRST* Championship: at the start of the first designated load-in period, according to the Public Schedule. If the Public Schedule is not available or there is no designated load-in period, the events begin at 4pm on the day prior to pits opening.
- District Events: when pits open

Examples of activity prohibited by this rule include:

- a. working on the ROBOT at the team's shop after load-in for the event has begun,
- b. working on ROBOT parts at night at the team's hotel, and
- c. running a 3D printer or other automated manufacturing process overnight producing ROBOT parts.

Note that [E108 and E401](#) impose additional restrictions on work done on the ROBOT or ROBOT materials while attending an event.

This rule is intended to increase equity between teams with significant travel to an event and those nearby (close teams would otherwise have an advantage by being able to work on their ROBOT, in their shop, until it's time to go to the event).

## 9.4 BUMPER Rules

A BUMPER is a required assembly which attaches to the ROBOT frame. BUMPERS protect ROBOTS from damaging/being damaged by other ROBOTS and FIELD elements. Criteria used in writing these rules include the following:

- minimize variety of BUMPERS so teams can expect consistency,
- minimize the amount of design challenge in creating BUMPERS,
- minimize cost of BUMPER materials, and
- maximize use of relatively ubiquitous materials.

**R401** \*BUMPERS should protect all corners. ROBOTS are required to use BUMPERS to protect all outside corners of the FRAME PERIMETER. For adequate protection, at least 6 in. (~16 cm) of BUMPER must be placed on each side of each outside corner (see Figure 9-3) and must extend to within ¼ in. (~6 mm) of the FRAME PERIMETER corner. If a FRAME PERIMETER side is shorter than 12 in. (~31 cm), that entire FRAME PERIMETER side must be protected by a BUMPER (see Figure 9-4). A round or circular FRAME PERIMETER, or segment of the FRAME PERIMETER, is considered to have an infinite number of corners, therefore the entire frame or frame segment must be completely protected by BUMPERS.

The dimension defined in this rule is measured along the FRAME PERIMETER. The portion of the BUMPER that extends beyond the corner of the FRAME PERIMETER is not included in the 6 in. (~16 cm) requirement. See Figure 9-3.

Figure 9-3 BUMPER corner examples

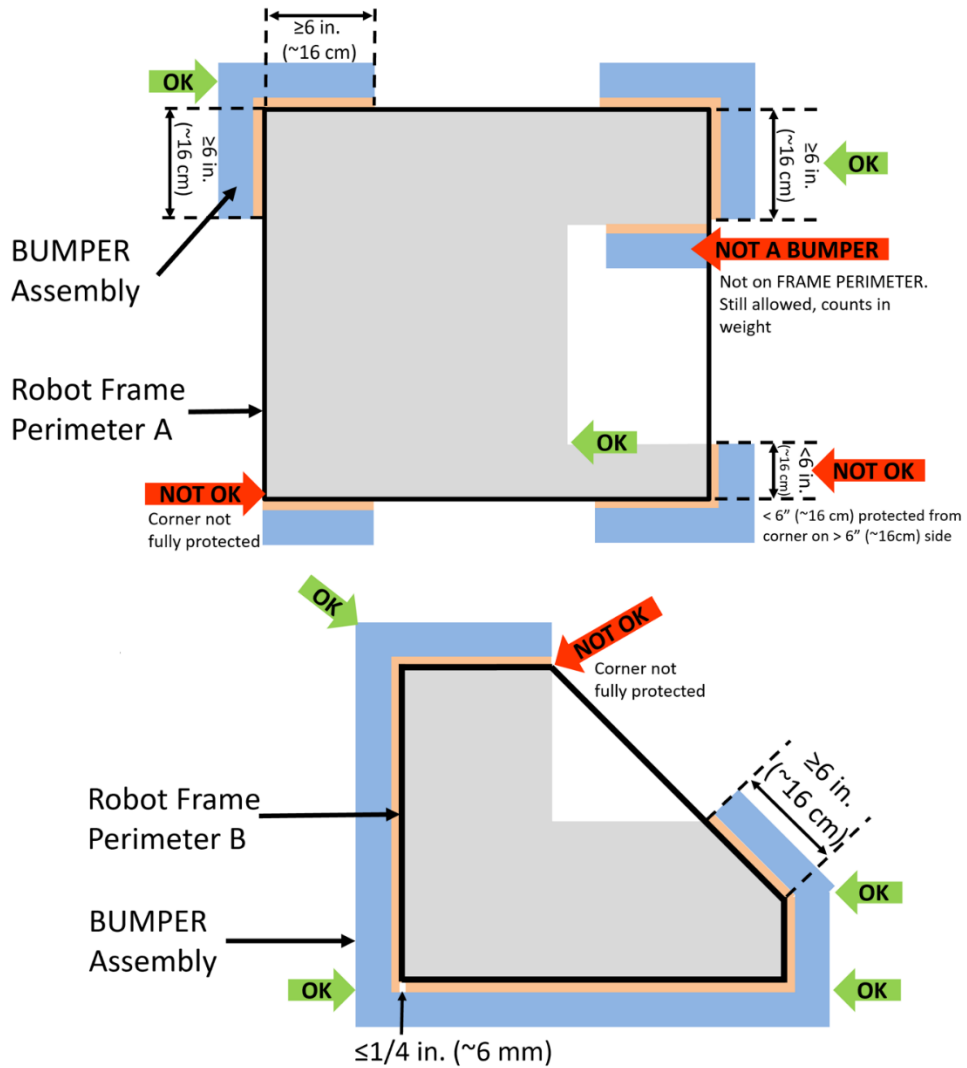
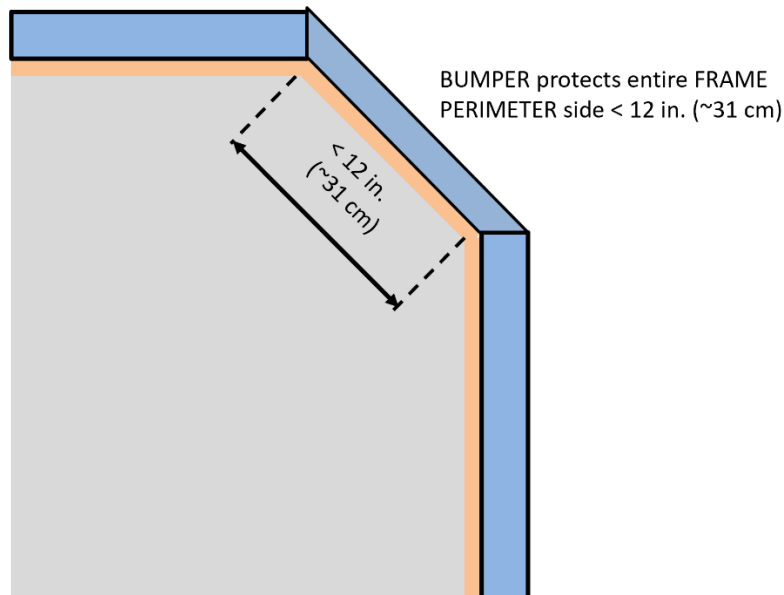



Figure 9-4 BUMPER around full side/corner



- R402** \***BUMPERS must stay low.** BUMPERS must be located entirely within the BUMPER ZONE, which is the volume contained between the floor and a virtual horizontal plane 7½ in. (~19 cm) above the floor in reference to the ROBOT standing normally on a flat floor. BUMPERS do not have to be parallel to the floor.

This measurement is intended to be made as if the ROBOT is resting on a flat floor (without changing the ROBOT configuration), not relative to the height of the ROBOT from the FIELD carpet. Examples include:

Example 1: A ROBOT that is at an angle while navigating the FIELD has its BUMPERS outside the BUMPER ZONE. If this ROBOT were virtually transposed onto a flat floor, and its BUMPERS are in the BUMPER ZONE, it meets the requirements of this rule.

Example 2: A ROBOT deploys a MECHANISM which lifts the BUMPERS outside the BUMPER ZONE (when virtually transposed onto a flat floor). This violates this rule.

- R403** \***BUMPERS shouldn't move.** BUMPERS must not be articulated, relative to the FRAME PERIMETER.
- R404** \***BUMPERS must come off.** BUMPERS must be designed for quick and easy installation and removal to facilitate inspection and weighing.

As a guideline, BUMPERS should be able to be installed or removed by 2 people in fewer than 5 minutes.

- R405** \***BUMPERS indicate your ALLIANCE.** Each ROBOT must be able to display red or blue BUMPERS to reflect their ALLIANCE color, as assigned in the MATCH schedule distributed at the event (as described in [Section 11.1 MATCH Schedules](#)). BUMPER markings visible when installed on the ROBOT, other than the following, are prohibited:
- those required per [R406](#),
  - hook-and-loop tape or snap fasteners backed by the hard parts of the BUMPER,

- C. solid white *FIRST* logos between 4¾ in. (~12 cm) and 5¼ in. wide (~13 cm) (i.e. comparable to those available in the [CHARGED UP Virtual Kit](#)), and
- D. narrow areas of underlying fabric exposed at seams, corners, or folds.

The FRAME PERIMETER facing surfaces of BUMPERS are not “displayed” and thus this rule does not apply.

**R406 \*Team number on BUMPERS.** Team numbers must be displayed and positioned on the BUMPERS such that an observer walking around the perimeter of the ROBOT can unambiguously tell the team’s number from any point of view and meet the following additional criteria:

- A. consist of only white Arabic numerals at least 4 in. (~11 cm) high, at least ½ in. (~13 mm) in stroke width,

The ½ in. (~13 mm) stroke width requirement applies to the majority of the stroke. Font elements less than ½ in. (~13 mm) such as serifs, rounded edges, small hairlines or gaps, etc. are permitted as long as the majority of the stroke meets the sizing requirement and the numbers are unambiguous.

- B. must not wrap around sharp corners (less than 160°) of the FRAME PERIMETER, and
- C. may not substitute logos or icons for numerals.

There is no prohibition against splitting team numbers onto different sections of BUMPER. The intent is that the team’s number is clearly visible and unambiguous so that Judges, REFEREES, Announcers, and other teams can easily identify competing ROBOTS.

This marking is intended to display the team number only, not to intentionally change the surface characteristics of the BUMPER. Excessive material usage as part of any team number marking will invite close scrutiny.

**R407 \*BUMPER weight limit.** Each set of BUMPERS (including any fasteners and/or structures that attach them to the ROBOT) must weigh no more than 15 lbs. (~6 kg).

If a multi-part attachment system is utilized (e.g. interlocking brackets on the ROBOT and the BUMPER), then the elements permanently attached to the ROBOT will be considered part of the ROBOT, and the elements attached to the BUMPERS will be considered part of the BUMPER. Each element must satisfy all applicable rules for the relevant system.

**R408 \*BUMPER construction.** BUMPERS must be constructed as follows (see Figure 9-7):

- A. be backed by ¾ in. thick (nominal, ~19mm) by 5 in. ± ½ in. (~127 mm ± 12.7 mm) tall plywood, Oriented Strand Board (OSB) or solid wood (with the exception of balsa). Small clearance pockets to accommodate minor protrusions permitted per [R101](#) and/or access holes needed to access mounting hardware in the wood backing are permitted, as long as they do not significantly affect the structural integrity of the BUMPER.

¾ in. plywood and OSB refer to items sold by VENDORS as that material and thickness, teams may not fabricate their own plywood or OSB. Other engineered woods such as Fiberboard or Particle Board are not likely to survive the rigors of *FIRST* Robotics Competition gameplay and thus not permitted per A.

Note: ¾ in. plywood is often marked according to the actual dimension ( $\frac{23}{32}$ ”) not the nominal size. Plywood sold as  $\frac{23}{32}$ ” meets the requirements of [A](#).

- B. hard BUMPER parts allowed per [A](#), [E](#), [E](#), and [G](#) must not extend more than 1 in. (~25 mm) beyond the FRAME PERIMETER (measured as shown in Figure 9-5).

Figure 9-5 Hard parts of BUMPER corners

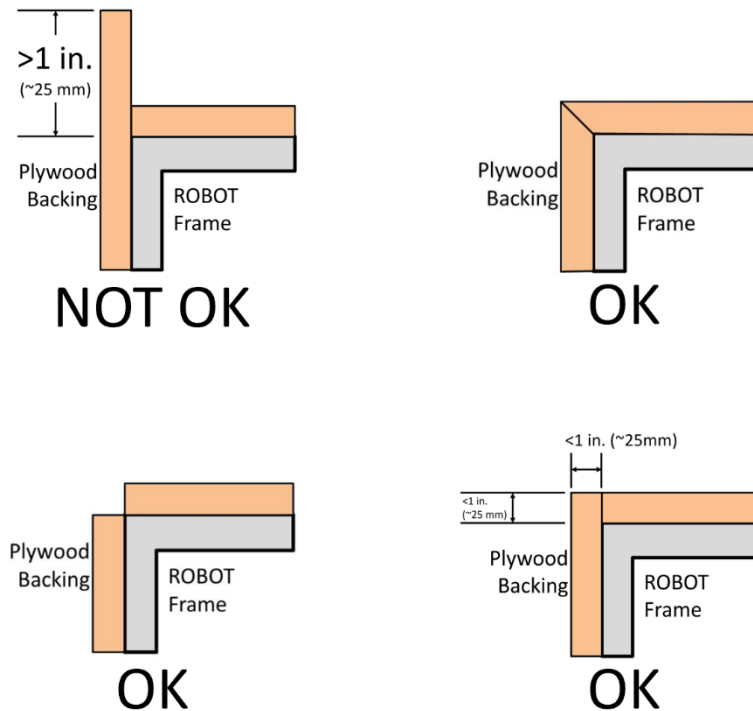

- C. use a stacked pair of 2½ in. (~63 mm) round, petal, or hex “pool noodles” (solid or hollow) as the BUMPER cushion material (see Figure 9-7). All pool noodles used in a BUMPER set (e.g. red set of BUMPERS) may not be modified (with the exception of cutting to length or cutting to facilitate mating pool noodles at the corners as required by [R409](#)) or deformed and must be the same diameter, cross section, and density (e.g. all round hollow or all hex solid). Per [R409](#) cushion material may extend beyond the end of the plywood in order to fill a corner (see Figure 9-8). To assist in applying the fabric covering, soft fasteners may be used to attach the pool noodles to the wood backing, so long as the cross section in Figure 9-7 is not significantly altered (e.g. tape compressing the pool noodles).

“2½ in. (~63 mm) pool noodles” are pool noodles either sold as 2½ in. (~63 mm) diameter or that measure between 2¼ in. (~57 mm) pool noodles and 2¾ in. (~70 mm) diameter.

All pool noodles used on a ROBOT must be the same in order to maintain the desired interaction between ROBOTS in the cases of BUMPER-to-BUMPER contact. BUMPERS containing pool noodles of vastly different construction may cause a “ramp” effect when interacting with other BUMPERS.

Minor noodle compression as a result of smoothing BUMPER fabric or rounding a FRAME PERIMETER corner is not considered deformed. Any compression beyond that, e.g. for the purposes of flattening the pool noodle, is deformation and a violation of [C](#).

- D. be covered with a rugged, smooth cloth with no additional coating applied by the team (multiple layers of cloth and seams are permitted if needed to accommodate [R405](#) and/or [R406](#), provided the cross section in Figure 9-7 is not significantly altered).

Silk and bedding are not considered rugged cloths, however 1000D Cordura is. Tape (e.g. gaffer's tape) matching the BUMPER color is allowed to patch small holes on a temporary basis.

It is expected that there may be multiple layers of cloth as fabric is folded to accommodate the corners and seams of BUMPERS.

The cloth must completely enclose all exterior surfaces of the wood and pool noodle material when the BUMPER is installed on the ROBOT. The fabric covering the BUMPERS must be solid in color.

- E. optionally use metal angle, as shown in Figure 9-7 or other fasteners (e.g. staples, screws, adhesives, etc.) to clamp cloth.
- F. optionally use metal brackets (i.e. angle or sheet metal) or other fasteners (e.g. staples, screws, adhesives, etc.) to attach BUMPER segments to each other (see Figure 9-6).

Figure 9-6 Example uses of brackets in BUMPER corners

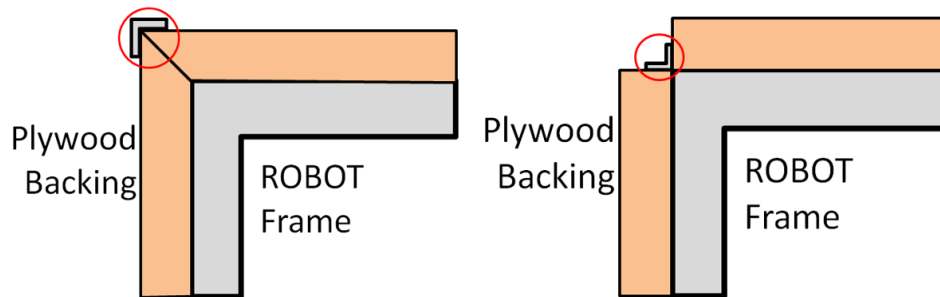

- G. must attach to the FRAME PERIMETER of the ROBOT with a rigid fastening system to form a tight, robust connection to the main structure/frame (e.g. not attached with hook-and-loop tape, tape, or cable ties). The attachment system must be designed to withstand vigorous game play. All removable fasteners (e.g. bolts, locking pins, pip-pins, etc.) will be considered part of the BUMPERS.

Figure 9-7 BUMPER vertical cross section

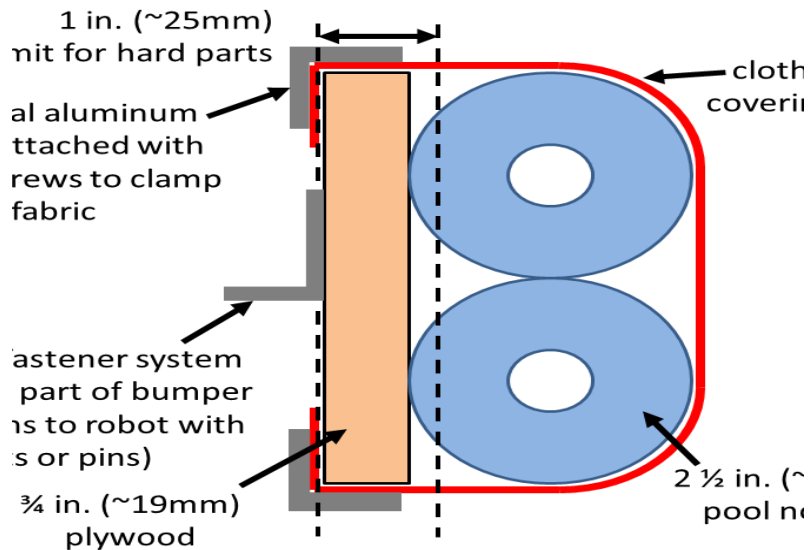

- R409** \*Fill BUMPER corners. Corner joints between BUMPERS must be filled with pool noodle material. Examples of implementation are shown in Figure 9-8.

Figure 9-8 Soft parts of BUMPER corners

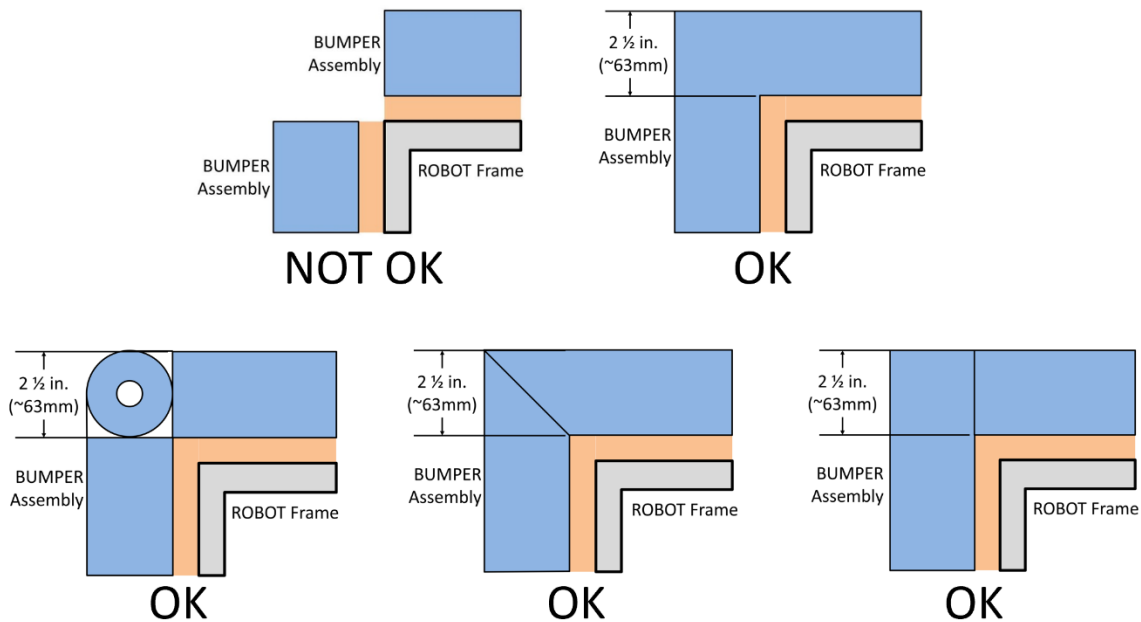

- R410** \*BUMPERS must be supported. BUMPERS must be supported by the structure/frame of the ROBOT (see Figure 9-9). To be considered supported, a minimum of 1/2 in. (~13 mm) at each end of each BUMPER wood segment must be backed by the FRAME PERIMETER ( $\leq 1/4$  in. gap, ~6mm). “Ends” exclude hard BUMPER parts which extend past the FRAME PERIMETER permitted by [R408-B](#). Additionally, any gap between the backing material and the frame:

- A. must not be greater than 1/4 in. (~6 mm) deep or

B. not more than 8 in. (~20 cm) wide

Figure 9-9 BUMPER support examples

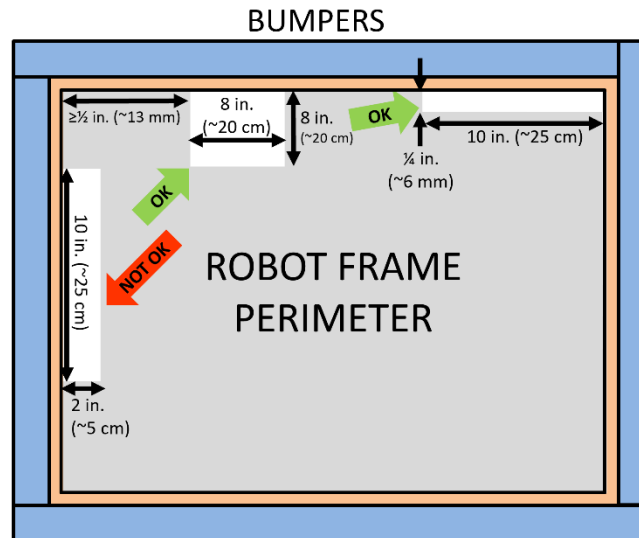

The intent of this rule is to make sure the BUMPER wood is properly supported to minimize the likelihood of breakage on impact. Flexible ROBOT elements, such as thin plastic, do not accomplish this intent and are not considered “structure/frame” of the ROBOT.

## 9.5 Motors & Actuators

**R501 \*Allowable motors.** The only motors and actuators permitted include the following (in any quantity):

Table 9-1 Motor allowances

Motor Name	Part Numbers Available	
AndyMark 9015	am-0912	AndyMark 9015
AndyMark NeveRest	am-3104	
AndyMark PG	am-2161 (alt. PN am-2765)	am-2194 (alt. PN am-2766)
AndyMark RedLine Motor	am-3775	am-3775a
AndyMark Snow Blower Motor	am-2235	am-2235a
Banebots	am-3830	M5 – RS550-12
	M7-RS775-18	RS550VC-7527
	RS775WC-8514	RS550



Motor Name	Part Numbers Available	
CIM	FR801-001	PM25R-45F-1004
	M4-R0062-12	PM25R-45F-1003
	AM802-001A	PMR25R-45F-1003
	217-2000	PMR25R-44F-1005
	PM25R-44F-1005	am-0255
CTR Electronics/VEX Robotics Falcon 500	217-6515	19-708850
	am-6515	am-6515_Short
Current/former KOP automotive motors	Denso AE235100-0160	Denso 262100-3040
	Denso 5-163800-RC1	Bosch 6 004 RA3 194-06
	Denso 262100-3030	Johnson Electric JE-PLG-149
		Johnson Electric JE-PLG-410
Nidec Dynamo BLDC Motor	am-3740	DM3012-1063
Playing with Fusion Venom	BDC-10001	
REV Robotics HD Hex	REV-41-1291	
REV Robotics NEO Brushless	REV-21-1650 (v1.0 or v1.1)	
REV Robotics NEO 550	REV-21-1651	
VEX BAG	217-3351	
VEX Mini-CIM	217-3371	
West Coast Products RS775 Pro	217-4347	

Electrical solenoid actuators, no greater than 1 in. (nominal) stroke and rated electrical input power no greater than 10 watts (W) continuous duty at 12 volts (VDC) (if qualifying actuator is then used at 24V, it must be approved by the manufacturer for use at 24V)

Fans, no greater than 120mm (nominal) size and rated electrical input power no greater than 10 watts (W) continuous duty at 12 volts (VDC)

Hard drive motors part of a legal COTS computing device

Factory installed vibration and autofocus motors resident in COTS computing devices (e.g. rumble motor in a smartphone).

PWM COTS servos with a retail cost < \$75.

Motors integral to a COTS sensor (e.g. LIDAR, scanning sonar, etc.), provided the device is not modified except to facilitate mounting

1 compressor compliant with [R806](#) and used to compress air for the ROBOT'S pneumatic system

**Motor Name**
**Part Numbers Available**

Linear actuators rated for 12V and wired downstream of a breaker 20A or less

For servos, note that the roboRIO is limited to a max current output of 2.2A on the 6V rail (12.4W of electrical input power). Teams should make sure that their total servo power usage remains below this limit at all times.

Given the extensive amount of motors allowed on the ROBOT, teams are encouraged to consider the total power available from the ROBOT battery during the design and build of the ROBOT. Drawing large amounts of current from many motors at the same time could lead to drops in ROBOT battery voltage that may result in tripping the main breaker or trigger the brownout protection of the roboRIO. For more information about the roboRIO brownout protection and measuring current draw using the PDP/PDH, see [roboRIO Brownout and Understanding Current Draw](#).

AndyMark PG Gearmotors are sold with labeling based on the entire assembly. Assemblies labeled am-3651 through am-3656 contain legal motors specified in the table above. These motors may be used with or without the provided gearbox.

**R502** **\*Don't modify motors (mostly).** The integral mechanical and electrical system of any motor must not be modified. Motors, servos, and electric solenoids used on the ROBOT shall not be modified in any way, except as follows:

- A. The mounting brackets and/or output shaft/interface may be modified to facilitate the physical connection of the motor to the ROBOT and actuated part.
- B. The electrical leads may be trimmed to length as necessary and connectors or splices to additional wiring may be added.
- C. The locking pins on the window motors (P/N 262100-3030 and 262100-3040) may be removed.
- D. The connector housings on KOP automotive motors listed in Table 9-1 may be modified to facilitate lead connections.
- E. Servos may be modified as specified by the manufacturer (e.g. re-programming or modification for continuous rotation).
- F. The wiring harness of the Nidec Dynamo BLDC Motor may be modified as documented by *FIRST* in [Nidec Dynamo BLDC Motor with Controller](#).
- G. Minimal labeling may be applied to indicate device purpose, connectivity, functional performance, etc.
- H. Any number of #10-32 plug screws may be removed from the Falcon 500.
- I. Insulation may be applied to electrical terminals.
- J. Repairs, provided the performance and specifications are unchanged.
- K. Maintenance recommended by the manufacturer.

The intent of this rule is to allow teams to modify mounting tabs and the like, not to gain a weight reduction by potentially compromising the structural integrity of any motor.

**R503** **\*Power (most) actuators off of approved devices.** With the exception of servos, fans, or motors integral to sensors of COTS computing devices permitted in [R501](#), each actuator must be controlled by a power regulating device. The only power regulating devices for actuators permitted on the ROBOT include:

- A. motor controllers,

- a. DMC 60/DMC 60c Motor Controller (P/N 410-334-1, 410-334-2),
  - b. Jaguar Motor Controller (P/N MDL-BDC, MDL-BDC24, and 217-3367) connected to PWM only,
  - c. Nidec Dynamo, BLDC Motor with Controller to control integral actuator only (P/N 840205-000, am-3740)
  - d. SD540 Motor Controller (P/N SD540x1, SD540x2, SD540x4, SD540Bx1, SD540Bx2, SD540Bx4, SD540C),
  - e. Spark Motor Controller (P/N REV-11-1200),
  - f. Spark MAX Motor Controller (P/N REV-11-2158),
  - g. Talon FX Motor Controller (P/N 217-6515, 19-708850, am-6515, am-6515\_Short) for controlling integral Falcon 500 only,
  - h. Talon Motor Controller (P/N CTRE\_Talon, CTRE\_Talon\_SR, and am-2195),
  - i. Talon SRX Motor Controller (P/N 217-8080, am-2854, 14-838288),
  - j. Venom Motor with Controller (P/N BDC-10001) for controlling integral motor only,
  - k. Victor 884 Motor Controller (P/N VICTOR-884-12/12),
  - l. Victor 888 Motor Controller (P/N 217-2769),
  - m. Victor SP Motor Controller (P/N 217-9090, am-2855, 14-868380), and
  - n. Victor SPX Motor Controller (P/N 217-9191, 17-868388, am-3748),
- B. relay modules,
- a. Spike H-Bridge Relay (P/N 217-0220 and SPIKE-RELAY-H),
  - b. Automation Direct Relay (P/N AD-SSR6M12-DC-200D, AD-SSRM6M25-DC-200D, AD-SSR6M40-DC-200D), and
  - c. Power Distribution Hub (PDH) switched channel (P/N REV-11-1850) for controlling non-actuator CUSTOM CIRCUITS only,
- C. pneumatics controllers,
- a. Pneumatics Control Module (P/N am-2858, 217-4243) and
  - b. Pneumatic Hub (P/N REV-11-1852).

Note: The Automation Direct Relays are single directional. Per [R504](#) they may not be wired together in an attempt to provide bi-directional control.

**R504** \*Don't overload controllers. Each power regulating device may control electrical loads per Table 9-2. Unless otherwise noted, each power regulating device shall control 1 and only 1 electrical load.

Table 9-2 Power regulating device allotments

Electrical Load	Motor Controller	Relay Module	Pneumatics Controller
AndyMark RedLine Motor			
Banebots			
CIM			
REV Robotics NEO Brushless	Yes	No	No
REV Robotics NEO 550			
VEX Mini-CIM			
WCP RS775 Pro			
AndyMark 9015	Yes		
VEXpro BAG	(up to 2 per controller)	No	No

Electrical Load	Motor Controller	Relay Module	Pneumatics Controller
AndyMark PG KOP Automotive Motors NeveRest Snow Blower Motor REV Robotics HD Hex	Yes (up to 2 per controller)	Yes	No
Linear Actuator	Yes (20A breaker max)	Yes (20A breaker max)	No
CTR Electronics/VEX Falcon 500 Nidec Dynamo BLDC Motor w/ Controller Playing With Fusion Venom	Yes (integrated controller only)	No	No
Compressor	No	Yes	Yes
Pneumatic Solenoid Valves	No	Yes (multiple)	Yes (1 per channel)
Electric Solenoids	Yes (multiple)	Yes (multiple)	Yes (1 per channel)
CUSTOM CIRCUITS	Yes (multiple)	Yes (multiple)	Yes (multiple)

**R505** \*Control servos safely. Servos must be connected to, and only to, 1 of the following:

- PWM ports on the roboRIO,
- PWM ports on a WCP Spartan Sensor Board (P/N WCP-0045), or
- REV Robotics Servo Power Module (P/N REV-11-1144).

## 9.6 Power Distribution

In order to maintain safety, the rules in this section apply at all times while at the event, not just while the ROBOT is on the FIELD for MATCHES.

**R601** \*Battery limit – everyone has the same power. The only legal source of electrical energy for the ROBOT during the competition, the ROBOT battery, must be 1 and only 1 non-spillable sealed lead acid (SLA) battery with the following specifications:

- Nominal voltage: 12V
- Nominal capacity at 20-hour discharge rate: minimum 17Ah, maximum 18.2Ah
- Shape: Rectangular
- Nominal Dimensions: 7.1 in. x 3 in. x 6.6 in., +/- .1 in. for each dimension (~ 180 mm x 76mm x 168 mm, +/- 2.5 mm for each dimension)
- Nominal weight: 11lbs. to 14.5 lbs. (~5 kg. to 6.5 kg.)
- Terminals: Nut and bolt style

Examples of batteries which meet these criteria include:

- Energys (P/N NP18-12, NP18-12B, NP18-12BFR),
- MK Battery (P/N ES17-12),

- c. Battery Mart (P/N SLA-12V18),
- d. Sigma (P/N SP12-18),
- e. Universal Battery (P/N UB12180),
- f. Power Patrol (P/N SLA1116),
- g. Werker Battery (P/N WKA12-18NB),
- h. Power Sonic (P/N PS-12180NB),
- i. Yuasa (P/N NP18-12B),
- j. Panasonic (P/N LC-RD-1217),
- k. Interstate Batteries (P/N BSL1116), and
- l. Duracell Ultra Battery (P/N DURA12-18NB).

Teams should be aware that they may be asked to provide documentation of the specifications of any battery not listed above.

Batteries should be charged in accordance with manufacturer's specification. (Please see the [FIRST Safety Manual](#) for additional information.)

- R602** \*Other batteries for cameras or computers only. COTS USB battery packs with a capacity of 100Wh or less (20000mAh at 5V) and 5V, 2.5 Amp max output per port, or batteries integral to and part of a COTS computing device or self-contained camera (e.g. laptop batteries, GoPro style camera, etc.) may be used to power COTS computing devices and any peripheral COTS input or output devices connected to the COTS computing device provided they are:
- A. securely fastened to the ROBOT,
  - B. connected only using unmodified COTS cables, and
  - C. charged according to manufacturer recommendations.

A COTS computing device is a non-roboRIO device used to process or collect sensor information (e.g. a "smart flashlight" is not a COTS computing device).

- R603** \*Charge batteries with safe connectors. Any battery charger used to charge a ROBOT battery must have the corresponding Anderson SB connector installed.
- R604** \*Charge batteries at a safe rate. Any battery charger used to charge a ROBOT battery may not be used such that it exceeds 6-Amp peak charge current.
- R605** \*Batteries are not ballast. No batteries other than those allowed per [R601](#) and [R602](#) are allowed on the ROBOT, whether or not they are being used to supply power.

For example, teams may not use additional batteries as extra weight on their ROBOTS.

- R606** \*Secure the battery. The ROBOT battery must be secured such that it will not dislodge during vigorous ROBOT interaction including if the ROBOT is turned over or placed in any arbitrary orientation.
- R607** \*Insulate battery connections. Each electrical terminal on the ROBOT battery, main breaker, and their connections (lugs, stripped wire ends, etc.) to the wire must be fully insulated at all times.
- R608** \*Limit non-battery energy. Non-electrical sources of energy used by the ROBOT (i.e., stored at the start of a MATCH) shall come only from the following sources:
- A. compressed air stored in the pneumatic system that has been charged in compliance with [R806](#) and [R807](#),
  - B. a change in the altitude of the ROBOT center of gravity,
  - C. storage achieved by deformation of ROBOT parts,
  - D. closed-loop COTS pneumatic (gas) shocks, or

E. air-filled (pneumatic) wheels.

- R609** \*Connect main power safely. The 1 ROBOT battery, a single pair of Anderson Power Products (or APP) 2-pole SB type connectors, the 1 main 120-amp (120A) surface mount circuit breaker (Cooper Bussman P/N CB185-120, CB185F-120, CB285-120 CB285F-120, CB285120F or Optifuse P/N 153120, 253120), and the 1 power distribution device (CTR Electronics Power Distribution Panel, PDP, P/N am-2856, 217-4244, 14-806880 or REV Robotics Power Distribution Hub, PDH, P/N REV-11-1850) shall be connected with 6 AWG (7 SWG or 16 mm<sup>2</sup>) copper wire or larger, with no additional devices or modifications (with the exception of monitoring circuitry permitted by [R625](#)), as shown in Figure 9-10.

Figure 9-10 Electrical connection diagram

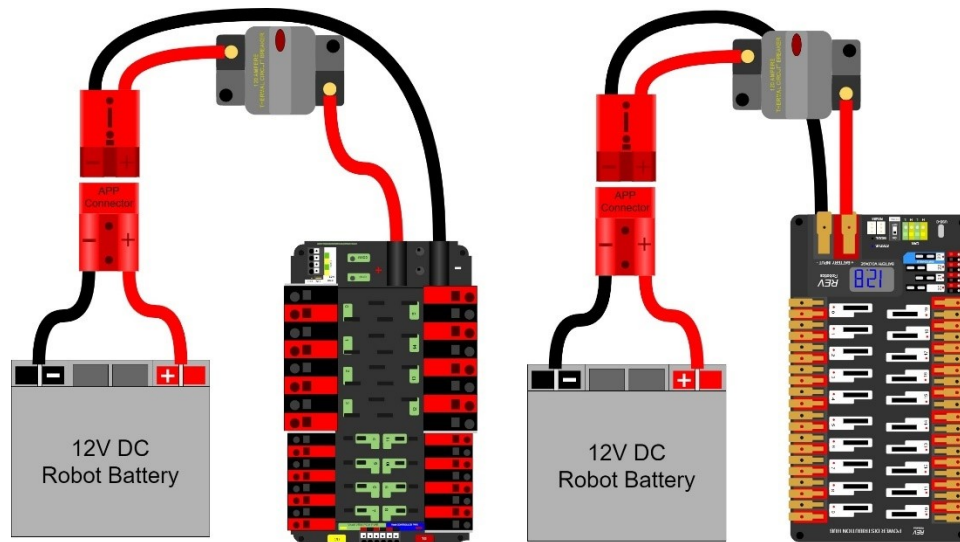

“SB type” refers to SB type only (e.g. SB-50, SB-120, etc.), not SBS or any other part type beginning with SB. All batteries supplied by FIRST (such as Spare Parts and international batteries) will have a red or pink SB50 connector installed which may not be removed.

The pink connectors included in the CHARGED UP KOP mate with the red SB50 connector.

- R610** \*1 breaker per circuit. All circuits, with the exceptions of those listed in [R615](#) and [R617](#), must connect to, and have power sourced solely by, a single protected 12VDC WAGO connector pair (i.e. the load terminals, as shown in Figure 9-10) of the PDP/PDH, not the M6 cap screws.
- R611** \*The ROBOT frame is not a wire. All wiring and electrical devices shall be electrically isolated from the ROBOT frame. The ROBOT frame must not be used to carry electrical current.

Compliance with this rule is checked by observing a >120Ω resistance between either the (+) or (-) post within the APP connector that is attached to the PDP/PDH and any point on the ROBOT.

All legal motor controllers with metal cases are electrically isolated. They may be mounted directly to ROBOT frame COMPONENTS.

Note that some cameras, decorative lights, and sensors (e.g. some encoders, some IR sensors, etc.) have grounded enclosures or are manufactured with



conductive plastics. These devices must be electrically isolated from the ROBOT frame to ensure compliance with this rule.

- R612** \*Must be able to turn ROBOT on and off safely. The 120A circuit breaker must be quickly and safely accessible from the exterior of the ROBOT. This is the only 120A circuit breaker allowed on the ROBOT.

Examples considered not “quickly and safely accessible” include breakers covered by an access panel or door, or mounted on, underneath or immediately adjacent to moving COMPONENTS.

It is strongly recommended that the 120A circuit breaker location be clearly and obviously labeled so it can be easily found by FIELD STAFF during a MATCH.

- R613** \*Electrical system must be inspectable. The PDP/PDH, associated wiring, and all circuit breakers must be visible for inspection.

“Visible for inspection” does not require that the items be visible when the ROBOT is in STARTING CONFIGURATION, provided the team can make the items viewable during the inspection process.

- R614** \*No high voltage allowed. Any active electrical item that is not an actuator (specified in R501) or core control system item (specified in R710) is considered a CUSTOM CIRCUIT. CUSTOM CIRCUITS shall not produce voltages exceeding 24V.

- R615** \*Power roboRIO as specified. The roboRIO power input must be connected to either:

- A. the dedicated supply terminals on the PDP shown in Figure 9-11 or

*Figure 9-11 roboRIO power source on a PDP*

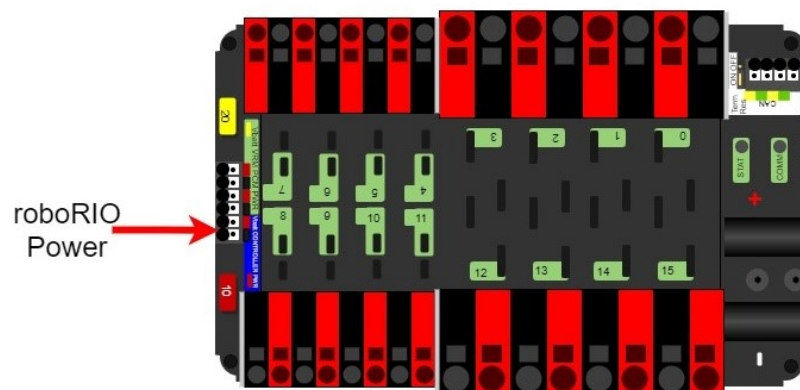

- B. the terminals of 1 of the non-switchable fused channels on the PDH (20,21,22) with a 10A fuse installed in the associated fuse holder.

No other electrical load shall be connected to that channel.

Figure 9-12 roboRIO power source on a PDH

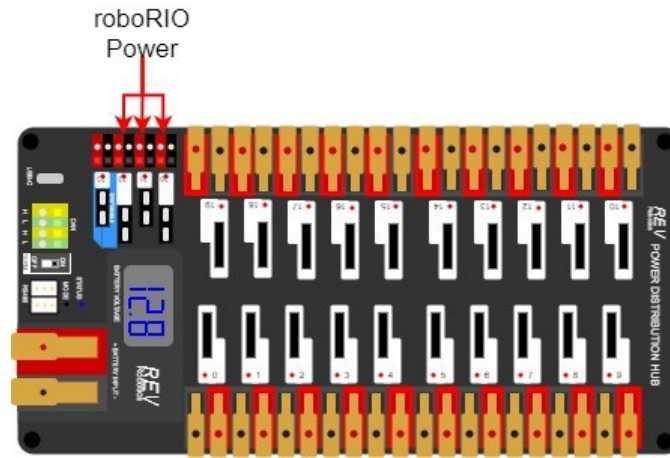

- R616 \*Power radio as specified – Part 1.** The wireless bridge (radio) power must be supplied by either:
- A. the 12V 2A output of a CTR Electronics Voltage Regulator Module (VRM) (P/N am-2857, 217-4245), as shown in Figure 9-13, and must be the only load connected to those terminals or

Figure 9-13 Radio power source from a VRM

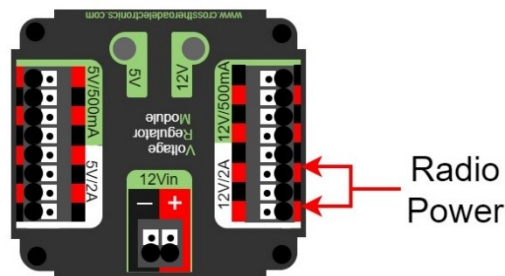

- B. using an Ethernet cable between a REV Radio Power Module (RPM) (P/N REV-11-1856) and the “18-24v POE” Ethernet port on the wireless bridge.

Note that this prohibits using any other active POE injector device to power the radio but does not prohibit using any PASSIVE CONDUCTORS to inject the VRM power into an Ethernet cable plugged into the radio port labeled “18-24v POE.”

- R617 \*Power radio as specified – Part 2.** The device supplying power to the wireless bridge per [R616](#) must be connected to either:
- A. the designated supply terminals at the end of the PDP, as shown in Figure 9-14. With the exception of a single CTR Electronics Pneumatics Control Module (PCM, P/N am-2858) or REV Robotics Pneumatic Hub (PH, P/N REV-11-1852), no other electrical load shall be connected to these PDP terminals.

Figure 9-14 VRM, PCM, and RPM power source on a PDP

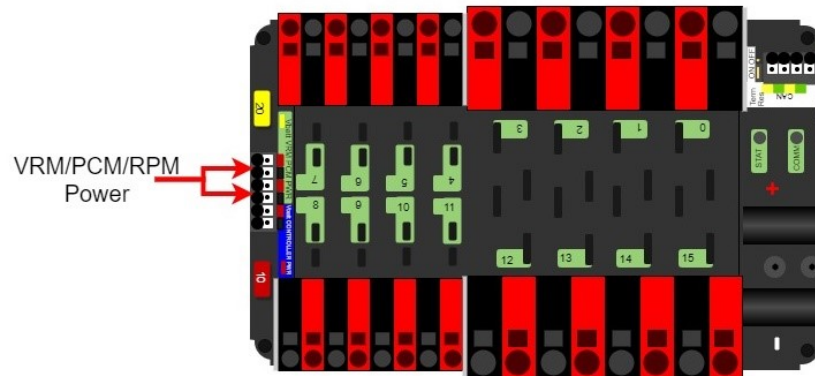

- B. the terminals of 1 of the non-switchable fused channels on the PDH (20,21,22) with a 10A fuse installed in the associated fuse holder. No other electrical load shall be connected to that channel.

Figure 9-15 VRM and RPM power source on a PDH

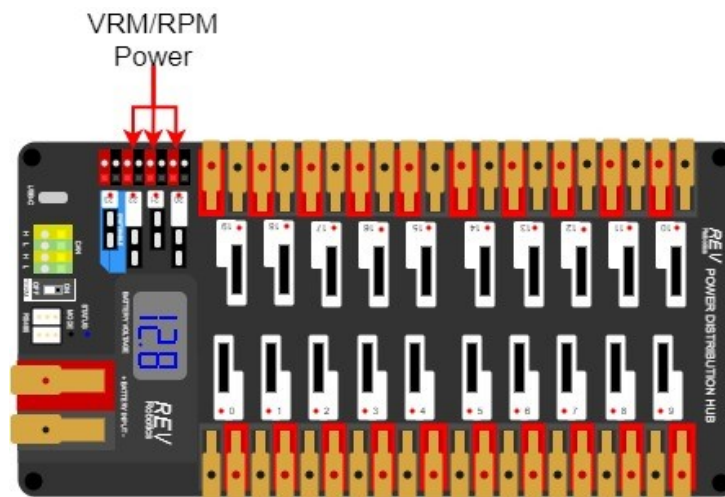

Please reference [How to Wire an FRC Robot](#) for wireless bridge wiring information.

- R618** \*Use PDP/PDH terminals as designed. Only 1 wire shall be connected to each terminal on the PDP/PDH.

If multi-point distribution of circuit power is needed (e.g. to provide power to multiple PCMs and/or VRMs from 1 20A circuit), then all incoming wires may be appropriately spliced into the main lead (e.g. using an insulated terminal block, crimped splice or soldered wire splice), and the single main lead inserted into the terminal to power the circuit.

- R619** \*Only use specified circuit breakers in PDP/PDH. The only circuit breakers permitted for use in the PDP/PDH are:

- A. Snap Action VB3-A Series or AT2-A, terminal style F57, 40A rating or lower,
- B. Snap Action MX5-A or MX5-L Series, 40A rating or lower, and

C. REV Robotics ATO auto-resetting breakers 40A rating or lower.

**R620 \*Only use specified fuses in PDP/PDH.** The only fuses permitted for use in the PDP/PDH are mini automotive blade fuses (ATM style) with the following values:

- A. for the PDP, values matching the value printed on the device’s corresponding fuse holder and
- B. for the PDH, 15A or lower with the exception of a single 20A fuse for powering a PCM or PH.

Note that these fuses must be pressed very firmly to seat properly. Improper seating can cause a device to reboot upon impact.

**R621 \*Protect circuits with appropriate circuit breakers.** Each branch circuit must be protected by 1 and only 1 circuit breaker or fuse on the PDP/PDH per Table 9-3. No other electrical load can be connected to the breaker or fuse supplying this circuit.

*Table 9-3 Branch circuit protection requirements*

Branch Circuit	Circuit Breaker Value	Quantity Allowed Per Breaker
Motor Controller	Up to 40A	1
CUSTOM CIRCUIT	Up to 40A	No limit
Automation Direct Relay 40A (*6M40*)	Up to 40A	1
Fans permitted per <a href="#">R501</a> and not already part of COTS computing devices	Up to 20A	No limit
Spike Relay Module	Up to 20A	1
Automation Direct Relay 25A (*6M25*)	Up to 20A	1
PCM/PH – with compressor	Up to 20A	1
Additional VRM (non-radio)/Additional PCM/PH (non-compressor)	Up to 20A	3 total
Automation Direct Relay 12A (*6M12*)	Up to 10A	1

This rule does not prohibit the use of smaller value breakers in the PDP/PDH or any fuses or breakers within CUSTOM CIRCUITS for additional protection.

**R622 \*Use appropriately sized wire.** All circuits shall be wired with appropriately sized insulated copper wire (SIGNAL LEVEL cables don’t have to be copper):

*Table 9-4 Breaker and wire sizing*

Application	Minimum Wire Size
31 – 40A breaker protected circuit	12 AWG (13 SWG or 4 mm <sup>2</sup> )
21 – 30A breaker protected circuit	14 AWG (16 SWG or 2.5 mm <sup>2</sup> )
6 – 20A breaker protected circuit	18 AWG

Application	Minimum Wire Size
<b>11-20A fuse protected circuit</b>  <b>Between the PDP dedicated terminals and the VRM/RPM or PCM/PH</b>  <b>Compressor outputs from the PCM/PH</b>  <b>Between the PDH and PCM/PH</b>	(19 SWG or 1 mm <sup>2</sup> )
<b>Between the PDP/PDH and the roboRIO</b>  <b>Between the PDH and VRM/RPM</b>  <b>≤5A breaker protected circuit</b>  <b>≤10A fuse protected circuit</b>	22 AWG (22 SWG or 0.5 mm <sup>2</sup> )
<b>VRM 2A circuits</b>	24 AWG (24 SWG or .25 mm <sup>2</sup> )
<b>roboRIO PWM port outputs</b>	26 AWG (27 SWG or 0.14 mm <sup>2</sup> )
<b>SIGNAL LEVEL circuits (i.e. circuits which draw ≤1A continuous and have a source incapable of delivering &gt;1A, including but not limited to roboRIO non-PWM outputs, CAN signals, PCM/PH Solenoid outputs, VRM 500mA outputs, RPM outputs, and Arduino outputs)</b>	28 AWG (29 SWG or .08 mm <sup>2</sup> )

Wires that are recommended by the device manufacturer or originally attached to legal devices are considered part of the device and by default legal. Such wires are exempt from this rule.

In order to show compliance with these rules, teams should use wire with clearly labeled sizes if possible. If unlabeled wiring is used, teams should be prepared to demonstrate that the wire used meets the requirements of this rule (e.g. wire samples and evidence that they are the required size).

**R623** \*Use only appropriate connectors. Branch circuits may include intermediate elements such as COTS connectors, splices, COTS flexible/rolling/sliding contacts, and COTS slip rings, as long as the entire electrical pathway is via appropriately gauged/rated elements.

Slip rings containing mercury are prohibited per [R203](#).

**R624** \*Use specified wire colors (mostly). All non-SIGNAL LEVEL wiring with a constant polarity (i.e., except for outputs of relay modules, motor controllers, or sensors) shall be color-coded along their entire length from the manufacturer as follows:

- A. red, yellow, white, brown, or black-with-stripe on the positive (e.g. +24VDC, +12VDC, +5VDC, etc.) connections
- B. black or blue for the common or negative side (-) of the connections

Exceptions to this rule include:

- C. wires that are originally attached to legal devices and any extensions to these wires using the same color as the manufacturer
- D. Ethernet cable used in POE cables

**R625** \*Don't modify critical power paths. CUSTOM CIRCUITS shall not directly alter the power pathways between the ROBOT battery, PDP/PDH, motor controllers, relays (per [R503-B](#)), motors and actuators (per [R501](#)), pneumatic solenoid valves, or other elements of the ROBOT control system (items explicitly mentioned in [R701](#)). Custom high impedance voltage monitoring or low impedance current monitoring circuitry connected to the ROBOT'S electrical system is acceptable, if the effect on the ROBOT outputs is inconsequential.

A noise filter may be wired across motor leads or PWM leads. Such filters will not be considered CUSTOM CIRCUITS and violate neither this rule nor [R717](#).

Acceptable signal filters must be fully insulated and must be 1 of the following:

- a 1 microfarad (1  $\mu$ F) or less, non-polarized, capacitor may be applied across the power leads of any motor on your ROBOT (as close to the actual motor leads as reasonably possible) or
- a resistor may be used as a shunt load for the PWM control signal feeding a servo.

## 9.7 Control, Command & Signals System

**R701** \*Control the ROBOT with a roboRIO. ROBOTS must be controlled via 1 programmable NI roboRIO or roboRIO 2.0 (P/N am3000 or am3000a, both versions referred to throughout this manual as "roboRIO"), with image version 2023\_v3.1 or later.

There are no rules that prohibit co-processors, provided commands originate from the roboRIO to enable and disable all power regulating devices. This includes motor controllers legally wired to the CAN bus.

**R702** \*Communicate with the ROBOT with the specified radio. 1 OpenMesh wireless bridge (P/N: OM5P-AN or OM5P-AC), that has been configured with the appropriate encryption key for your team number at each event, is the only permitted device for communicating to and from the ROBOT during the MATCH.

**R703** \*Use specific Ethernet port for roboRIO. The roboRIO Ethernet port must be connected to the wireless bridge port labeled "18-24 vPOE" (either directly, via a network switch, via an RPM, or via a CAT5 Ethernet pigtail).

Note: Placing a switch between the roboRIO and radio may impede the ability for FIELD STAFF to troubleshoot roboRIO connection issues on the FIELD. Teams may be asked to connect directly between the radio and the roboRIO as part of troubleshooting efforts.

**R704** \*Only use allowed ports and bandwidth to communicate with the ROBOT. Communication between the ROBOT and the OPERATOR CONSOLE may not exceed 4 Mbits/second and is restricted to network ports listed in Table 9-5.

Table 9-5 Open FMS ports

Port	Designation	Bi-directional?
UDP/TCP 1180-1190	Camera data from the roboRIO to dashboard software when the camera is connected the roboRIO via USB	Yes
TCP 1735	SmartDashboard	Yes



Port	Designation	Bi-directional?
UDP 1130	Dashboard-to-ROBOT control data	Yes
UDP 1140	ROBOT-to-Dashboard status data	Yes
HTTP 80	Camera connected via switch on the ROBOT	Yes
HTTP 443	Camera connected via switch on the ROBOT	Yes
UDP/TCP 554	Real-Time Streaming Protocol for h.264 camera streaming	Yes
UDP/TCP 1250	CTRE Diagnostics Server	Yes
UDP/TCP 5800-5810	Team use	Yes

Teams may use these ports as they wish if they do not employ them as outlined above (i.e. TCP 1180 can be used to pass data back and forth between the ROBOT and the Driver Station Software if the team chooses not to use the camera on USB).

Note that the 4 Mbit limit will be strictly enforced by the wireless bridge.

The [FMS Whitepaper](#) has more details on how to check and optimize bandwidth usage.

While *FIRST* makes every effort to provide a wireless environment that allows teams access to a full 4 Mbits/second data rate (with about 100 Kbit used for ROBOT control and status), at some events wireless conditions may not accommodate this.

- R705** \*Configure devices for your team number. The roboRIO, Driver Station Software, and wireless bridge must be configured to correspond to the correct team number, per the procedures defined in the [FIRST Robotics Competition Control System documentation](#).
- R706** \*Don't bypass the ARENA network. All signals must originate from the OPERATOR CONSOLE and be transmitted to the ROBOT via the ARENA Ethernet network.
- R707** \*No other wireless allowed. No form of wireless communication shall be used to communicate to, from, or within the ROBOT, except those required per [R702](#), [R706](#), and tags used for location detection systems if provided by the event.

Devices that employ signals in the visual spectrum (e.g. cameras) and non-RF sensors that don't receive human-originated commands (e.g. "beam break" sensors or IR sensors on the ROBOT used to detect FIELD elements) are not wireless communication devices and thus this rule doesn't apply.

- R708** \*Wireless bridge must be visible. The wireless bridge must be mounted on the ROBOT such that the diagnostic lights are visible to FIELD STAFF.

Teams are encouraged to mount the wireless bridge away from noise generating devices such as motors, PCM(s)/PH(s), and VRM(s)/RPM(s).

**R709** \*ROBOTS must have a signal light. ROBOTS must use at least 1, but no more than 2, diagnostic ROBOT Signal Light (RSL) (P/N 855PB-B12ME522 and/or am-3583).

Any RSL must be:

- A. mounted on the ROBOT such that it is easily visible while standing 3 ft. (~ 100 cm) away from at least one side of the ROBOT,
- B. connected to the "RSL" supply terminals on the roboRIO, and
- C. if using the 855PB-B12ME522, wired for solid light operation, by placing a jumper between the "La" and "Lb" terminals on the light per Figure 9-16.

Please see [How to Wire an FRC Robot](#) for connection details.

Figure 9-16 855PB-B12ME522 jumper wiring

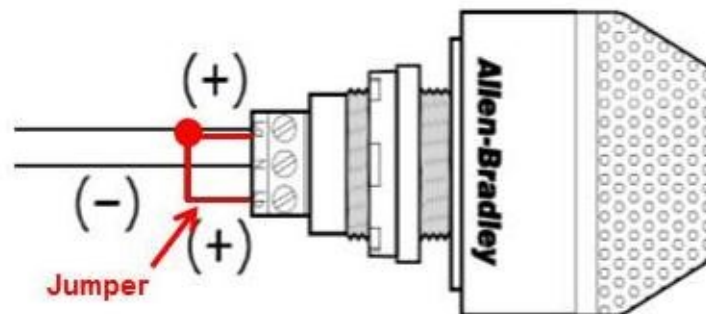

**R710** \*Only specified modifications to control system devices permitted. The Driver Station Software, roboRIO, PDP/PDH, PCM(s)/PH(s), VRM(s)/RPM(s), RSL, 120A breaker, motor controllers, MXP devices used to control actuators per [R713-C](#), relay modules (per [R503-B](#)), wireless bridge, and batteries shall not be tampered with, modified, or adjusted in any way (tampering includes drilling, cutting, machining, rewiring, disassembling, painting, etc.), with the following exceptions:

Please note that the Driver Station Software is a separate application from the Dashboard. The Driver Station Software may not be modified, while teams are expected to customize their Dashboard code.

- A. User programmable code in the roboRIO may be customized.
- B. Motor controllers may be calibrated as described in owner's manuals.
- C. Fans may be attached to motor controllers and may be powered from the power input terminals.
- D. If powering the compressor, the fuse on a Spike H-Bridge Relay may be replaced with a VB3A-20A Snap-Action circuit breaker.
- E. Wires, cables, and signal lines may be connected via the standard connection points provided on the devices.
- F. Fasteners (including adhesives) may be used to attach the device to the OPERATOR CONSOLE or ROBOT or to secure cables to the device.
- G. Thermal interface material may be used to improve heat conduction.
- H. Labeling may be applied to indicate device purpose, connectivity, functional performance, etc.
- I. Jumpers may be changed from their default location.
- J. Limit switch jumpers may be removed from a Jaguar motor controller and a custom limit switch circuit may be substituted.
- K. Device firmware may be updated with manufacturer supplied firmware.

- L. Integral wires on motor controllers may be cut, stripped, and/or connectorized.
- M. Devices may be repaired, provided the performance and specifications of the device after the repair are identical to those before the repair.
- N. The cover may be removed from the Talon SRX data port.
- O. Electrical tape may be applied to the aluminum plate inside the wireless bridge.
- P. The input terminal cover from the PDP may be omitted (no other element may be installed using the threaded holes to install something in place of the PDP terminal cover).
- Q. The roboRIO 2.0 SD card may be replaced with an SD card of any capacity.

Please note that while repairs are permitted, the allowance is independent of any manufacturer's warranty. Teams make repairs at their own risk and should assume that any warranty or return options are forfeited. Be aware that diagnosing and repairing COMPONENTS such as these can be difficult.

For more information about modification O, please see [this OM5P-AC Radio Modification article](#).

- R711** \***Don't connect motor outputs to roboRIO.** Neither 12VDC power nor relay module or motor controller outputs shall be directly connected to the roboRIO, with the exception of the designated 12VDC input.
- R712** \***Control PWM controllers from the roboRIO.** Every relay module (per [R503-B](#)), servo controller, and PWM motor controller shall be connected to a corresponding port (relays to Relay ports, servo controllers and PWM controllers to PWM ports) on the roboRIO (either directly or through a WCP Spartan Sensor Board) or via a legal MXP connection (per [R713](#)). They shall not be controlled by signals from any other source, with the exception of the Nidec Dynamo motor controller which must also be connected to the roboRIO Digital I/O.
- R713** \***Only approved MXP devices can control actuators.** If a motor is controlled via the MXP, its power regulating device must be connected by 1 of the following methods:
- A. directly to any PWM pins,
  - B. via a network of PASSIVE CONDUCTORS used to extend the PWM pins, or
  - C. via 1 approved ACTIVE DEVICE:
    - a. Kauai Labs navX MXP
    - b. Kauai Labs navX2 MXP
    - c. RCAL MXP Daughterboard
    - d. REV Robotics RIOduino
    - e. REV Robotics Digit Board
    - f. West Coast Products Spartan Sensor Board
    - g. Huskie Robotics HUSKIE 2.0 Board

A PASSIVE CONDUCTOR is any device or circuit whose capability is limited to the conduction and/or static regulation of the electrical energy applied to it (e.g. wire, splices, connectors, printed wiring board, etc.).

An ACTIVE DEVICE is any device capable of dynamically controlling and/or converting a source of electrical energy by the application of external electrical stimulus.

The "network of PASSIVE CONDUCTORS" only applies to the pins being used for PWM output to motors or servos. This means that connecting an ACTIVE DEVICE, such as a sensor to 1 MXP pin does not prevent other MXP pins from being used in accordance with [B](#).

- R714 \*Control CAN motor controllers from the roboRIO.** Each CAN motor controller must be controlled with signal inputs sourced from the roboRIO and passed via either a PWM (wired per [R713](#)) or CAN bus (either directly or daisy-chained via another CAN bus device) signal, but both shall not be wired simultaneously on the same device.

As long as the CAN bus is wired legally so that the heartbeat from the roboRIO is maintained, all closed loop control features of the CAN motor controller may be used. (That is, commands originating from the roboRIO to configure, enable, and specify an operating point for all CAN motor controller closed loop modes fit the intent of [R701](#)).

“Wired directly” includes via any series of PASSIVE CONDUCTORS (i.e. star or hub configurations using only PASSIVE CONDUCTORS are permitted.)

- R715 \*Control PCM/PH(S) from roboRIO.** Each PCM/PH must be controlled with signal inputs sourced from the roboRIO and passed via a CAN bus connection from the built-in CAN on the roboRIO (either directly or daisy-chained via another CAN bus device).
- R716 \*Connect the PDP/PDH to the roboRIO CAN bus.** The PDP/PDH CAN interface must be connected to the built-in CAN bus on the roboRIO (either directly or daisy-chained via another CAN bus device).

For documentation on how to wire the CAN bus connections see [How to Wire an FRC ROBOT](#).

- R717 \*Don't alter the CAN bus.** No device that interferes with, alters, or blocks communications among the roboRIO and the PDP/PDH, PCMs/PHs, and/or CAN motor controllers on the bus will be permitted.

Only 1 wire should be inserted into each Weidmuller CAN connector terminal. For documentation on how to wire the CAN bus connections see [How to Wire an FRC ROBOT](#).

- R718 \*USB to CAN adapter permitted.** Additional CAN bus connections may be added to the roboRIO using the CTR Electronics CANivore™ P/N 21-678682 USB-to-CAN adapter.

Any additional CAN bus added in this manner satisfies the requirements of [R714](#) (i.e. you may connect motor controllers to this additional bus).

## 9.8 Pneumatic System

In order to maintain safety, the rules in this section apply at all times while at the event, not just while the ROBOT is on the FIELD for MATCHES.

- R801 \*Only use explicitly permitted pneumatic parts.** To satisfy multiple constraints associated with safety, consistency, inspection, and constructive innovation, no pneumatic parts other than those explicitly permitted in this section shall be used on the ROBOT.
- R802 \*No custom pneumatics and meet minimum pressure ratings.** All pneumatic items must be COTS pneumatic devices and either:
- rated by their manufacturers for pressure of at least 125psi (~862 kPa) or
  - installed downstream of the primary relieving regulator (see R809), and rated for pressure of at least 70psi (~483 kPa)

Any pressure specification such as “working,” “operating,” “maximum,” etc. may be used to satisfy the requirements of this rule.

It is recommended that all pneumatic items be rated by their manufacturers for a working pressure of at least 60 psi (~414 kPa).

**R803 \*Don't modify pneumatics.** All pneumatic COMPONENTS must be used in their original, unaltered condition. Exceptions are as follows:

- A. tubing may be cut,
- B. wiring for pneumatic devices may be modified to interface with the control system,
- C. assembling and connecting pneumatic COMPONENTS using the pre-existing threads, mounting brackets, quick-connect fittings, etc.,
- D. removing the mounting pin from a pneumatic cylinder, provided the cylinder itself is not modified, and
- E. labeling applied to indicate device purpose, connectivity, functional performance, etc.

Do not, for example, paint, file, machine, or abrasively remove any part of a pneumatic COMPONENT – this would cause the part to become a prohibited item. Consider pneumatic COMPONENTS sacred.

**R804 \*Only use specific pneumatic devices.** The only pneumatic system items permitted on ROBOTS include the following items:

- A. pneumatic pressure vent plug valves functionally equivalent to those provided in the KOP,

Examples of acceptable valves include Parker PV609-2 or MV709-2.

- B. pressure relief valves functionally equivalent to those provided in the KOP,

Examples of acceptable valves include Norgren 16-004-011, 16-004-003 or McMaster-Carr 48435K714.

To be considered functionally equivalent the valve must be preset or adjustable to 125 psi (~862 kPa) and capable of relieving at least 1 scfm (~472 cm<sup>3</sup>/s).

- C. solenoid valves with a maximum ⅛ in. (nominal, ~3 mm) NPT, BSPP, or BSPT port diameter or integrated quick connect ¼ in. (nominal, ~6mm) outside diameter tubing connection,
- D. additional pneumatic tubing, with a maximum ¼ in. (nominal, ~6 mm) outside diameter,
- E. pressure transducers, pressure gauges, passive flow control valves (specifically “needle valve”), manifolds, and connecting fittings (including COTS pneumatic U-tubes),
- F. check and quick exhaust valves, provided that the requirements of [R813](#) are still met.
- G. shutoff valves which relieve downstream pressure to atmosphere when closed (may also be known as 3-way or 3-way exhausting valves),
- H. pressure regulators with the maximum outlet pressure adjusted to no more than 60 psi (~413 kPa),
- I. pneumatic cylinders, pneumatic linear actuators, and rotary actuators,
- J. pneumatic storage tanks (with the exception of white Clippard tanks P/N AVT-PP-41),
- K. 1 compressor that is compliant with [R806](#),
- L. debris or coalescing (water) filters, and
- M. Venturi valves (note: the high-pressure side of a Venturi valve is considered a pneumatic device and must follow all pneumatic rules. The vacuum side of a Venturi valve is exempt from the pneumatic rules per “a” in the blue box below).

The following devices are not considered pneumatic devices and are not subject to pneumatic rules (though they must satisfy all other rules):

- a device that creates a vacuum,
- closed-loop COTS pneumatic (gas) shocks,
- air-filled (pneumatic) wheels, and
- pneumatic devices not used as part of a pneumatic system (i.e. used in a way that does not allow them to contain pressurized air)

**R805** \*If using pneumatics, these parts are required. If pneumatic COMPONENTS are used, the following items are required as part of the pneumatic circuit and must be used in accordance with this section, as illustrated in Figure 9-17.

- 1 FIRST Robotics Competition legal compressor (per [R806](#)),
- a pressure relief valve (per [R804-B](#)) connected and calibrated (per [R811](#)),
- a Nason pressure switch (P/N SM-2B-115R/443) and/or REV Robotics Analog Pressure Sensor (P/N REV-11-1107) connected and wired per [R812](#),
- at least 1 pressure vent plug plumbed (per [R813](#)),
- stored pressure gauge and working pressure gauge (per [R810](#)), and
- 1 primary working pressure regulator (per [R808](#)).

Figure 9-17 Pneumatic circuitry

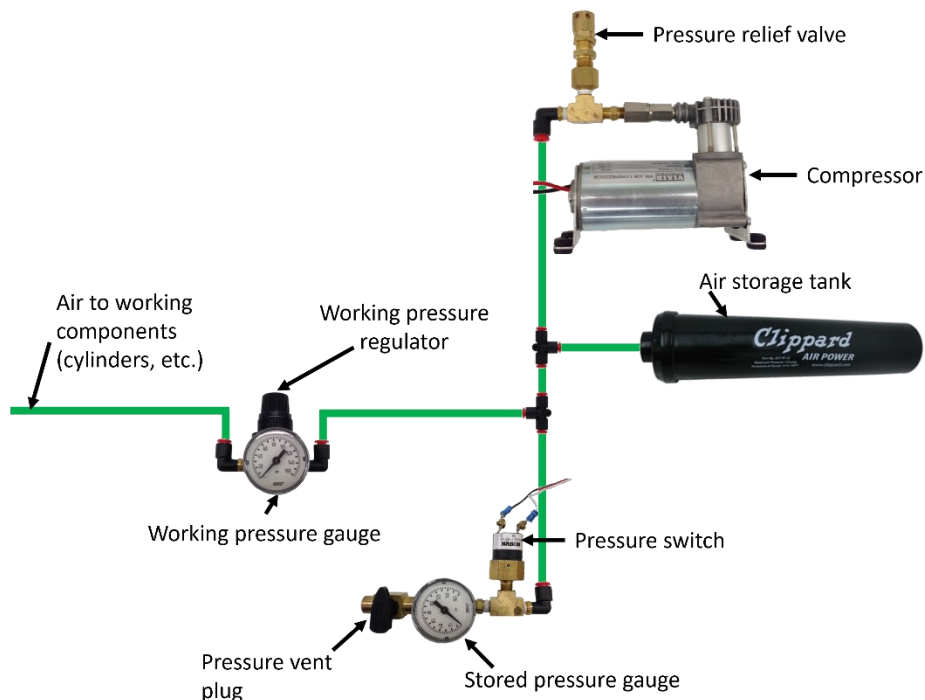

**R806** \*Compressed air from ROBOT compressor only. Throughout an event, compressed air on the ROBOT must be provided by its 1 onboard compressor only. Compressor specifications must not exceed nominal 1.1 cfm (~519 cm<sup>3</sup>/s) flow rate @ 12VDC at any pressure.

A ROBOT'S compressor may be substituted by another compressor, but a ROBOT may only have 1 designated compressor at a time, and all compressed air on the ROBOT must be sourced from a single compressor.



Note: Viair C-series compressors, which have a max working pressure of 120 PSI, are rated for intermittent pressures greater than 125 PSI and therefore meet the requirements of this rule.

**R807 \*Air storage pressure limit.** Stored air pressure on the ROBOT must be no greater than 120 psi (~827 kPa). No stored air pressure intended for the ROBOT may be located off-board the ROBOT.

**R808 \*Working air pressure limit.** Working air pressure (air pressure used to actuate devices) on the ROBOT must be no greater than 60 psi (~413 kPa) and must be provided through a single primary adjustable, relieving, pressure regulator.

Examples of acceptable valves include Norgren regulator P/N R07-100-RNEA and Monnier P/N 101-3002-1.

**R809 \*Limited devices at high pressure.** Only the compressor, relief valve, pressure switch, pressure vent plug, pressure gauge, storage tanks, tubing, pressure transducers, filters, and connecting fittings may be in the high-pressure pneumatic circuit upstream from the regulator.

It is recommended that all COMPONENTS in the high-pressure pneumatic circuit upstream from the regulator be rated for at least 115 psi (~793 kPa) working pressure.

**R810 \*Pressure gauges must be visible.** Pressure gauges must be placed in easily visible locations upstream and downstream of the regulator to display the stored and working pressures, respectively. Pressure gauges must show pressure in psi or kPa.

**R811 \*Relief valve requirements.** The relief valve must be attached directly to the compressor or attached by legal hard fittings (e.g. brass, nylon, etc.) connected to the compressor output port.

Teams are required to check and/or adjust the relief valve to release air at 125 psi (~861 kPa). The valve may or may not have been calibrated prior to being supplied to teams.

Instructions for adjusting the pressure relief valve can be found in the [Pneumatics Manual](#).

**R812 \*Pressure switch requirements.** The pressure switch must be connected to the high-pressure side of the pneumatic circuit (i.e. prior to the pressure regulator) to sense the stored pressure of the circuit.

It must be either:

A. Nason P/N SM-2B-115R/443 (wired as described) and/or

The 2 wires from the pressure switch must be connected directly to the pressure switch input of the PCM/PH controlling the compressor or, if controlled using the roboRIO and a relay, to the roboRIO. If connected to the roboRIO, the roboRIO must be programmed to sense the state of the switch and operate the relay module that powers the compressor to prevent over-pressuring the system.

B. REV Robotics P/N REV-11-1107 (wired as described)

The analog output of the sensor must be connected directly to analog input 0 of the PH (with firmware version 22.0.2 or newer) controlling the compressor.

The REV Robotics Analog Pressure Sensor may only be used with PH compressor control and may not be used with PCM compressor control.

**R813 \*Vent plug requirements.** Any pressure vent plug must be:

- A. connected to the pneumatic circuit such that, when manually operated, it will vent to the atmosphere to relieve all stored pressure in a reasonable amount of time and
- B. placed on the ROBOT so that it is visible and easily accessible.

**R814** \*Don't connect solenoid outputs together. The outputs from multiple solenoid valves must not be plumbed together.

## 9.9 OPERATOR CONSOLE

**R901** \*Use the specified Driver Station Software. The Driver Station Software provided by National Instruments ([install instructions found here](#)) is the only application permitted to specify and communicate the operating mode (i.e. AUTO/TELEOP) and operating state (Enable/Disable) to the ROBOT. The Driver Station Software must be version 22.0 or newer.

Teams are permitted to use a portable computing device of their choice (laptop computer, tablet, etc.) to host the Driver Station Software while participating in MATCHES.

**R902** \*The OPERATOR CONSOLE must have a visible display. The OPERATOR CONSOLE, the set of COMPONENTS and MECHANISMS used by the DRIVERS and/or HUMAN PLAYERS to relay commands to the ROBOT, must include a graphic display to present the Driver Station Software diagnostic information. It must be positioned within the OPERATOR CONSOLE so that the screen display can be clearly seen during inspection and in a MATCH.

**R903** \*Connect FMS Ethernet directly to the OPERATOR CONSOLE. Devices hosting the Driver Station Software must only interface with the FMS via the Ethernet cable provided at the DRIVER STATION (e.g. not through a switch). Teams may connect the FMS Ethernet cable to the device running the Driver Station Software directly via an Ethernet pigtail, or with a single-port Ethernet converter (e.g. docking station, USB-Ethernet converter, Thunderbolt-Ethernet converter, etc.). The Ethernet port on the OPERATOR CONSOLE must be easily and quickly accessible.

Teams are strongly encouraged to use pigtails on the Ethernet port used to connect to the FMS. Such pigtails will reduce wear and tear on the device's port and, with proper strain relief employed, will protect the port from accidental damage.

**R904** \*OPERATOR CONSOLE physical requirements. The OPERATOR CONSOLE must not

- A. be longer than 5 ft. (~152 cm),
- B. be deeper than 1 ft. 2 in. (~35 cm) (excluding any items that are held or worn by the DRIVERS during the MATCH),
- C. extend more than 6 ft. 6 in. (~198 cm) above the floor, or
- D. attach to the FIELD (except as permitted by [G301](#)).

There is a 4 ft. 6 in. (~137 cm) long by 2 in. (nominal) wide strip of hook-and-loop tape ("loop" side) along the center of the DRIVER STATION support shelf that should be used to secure the OPERATOR CONSOLE to the shelf, per [G301](#). See [Section 5.7.1 DRIVER STATIONS](#) for details.

Please note that while there is no hard weight limit, OPERATOR CONSOLES that weigh more than 30 lbs. (~13 kg.) will invite extra scrutiny as they are likely to present unsafe circumstances.

**R905** \*FIELD wireless only. Other than the system provided by the FIELD, no other form of wireless communications shall be used to communicate to, from, or within the OPERATOR CONSOLE.

Examples of prohibited wireless systems include, but are not limited to, active wireless network cards and Bluetooth devices. For the case of the *FIRST* Robotics Competition, a motion sensing input device (e.g. Microsoft Kinect) is not considered wireless communication and is allowed.

- R906** \*No unsafe **OPERATOR CONSOLES**. OPERATOR CONSOLES shall not be made using hazardous materials, be unsafe, cause an unsafe condition, or interfere with other DRIVE TEAMS or the operation of other ROBOTS.



## 10 INSPECTION & ELIGIBILITY RULES

This section describes the rules governing MATCH participation. A team has participated in a MATCH if any member of their DRIVE TEAM is in the ALLIANCE AREA, with or without the ROBOT on the FIELD, at the start of the MATCH.

At each event, the Lead ROBOT INSPECTOR (LRI) has final authority on the legality of any COMPONENT, MECHANISM, or ROBOT. INSPECTORS may re-inspect ROBOTS at any time to ensure compliance with the rules. Teams are encouraged to consult with INSPECTORS or the LRI if they have any questions regarding the legality of a ROBOT or about how to make a ROBOT legal.

The inspection process may progress in blocks, i.e. it may pause for a team's Practice MATCH, slot on the practice field, lunch break, etc. The process may employ various INSPECTORS throughout the process based on availability. At the team's discretion, they may request a different INSPECTOR or invite the Lead ROBOT INSPECTOR to participate in their ROBOT'S inspection.

While there is no specific defined procedure in place for teams to be re-inspected prior to Playoff MATCHES, it is typical for INSPECTORS to use the re-inspection discretion described above to do a limited re-inspection on all ROBOTS near the end of QUALIFICATIONS or beginning of Playoff MATCHES to help identify any modifications that should be re-inspected per [1104](#).

ROBOTS are permitted to participate in scheduled Practice MATCHES prior to passing inspection. However, the FTA, LRI, or Head REFEREE may determine at any time that the ROBOT is unsafe and may prohibit further participation in Practice MATCHES until the condition is corrected and/or the ROBOT passes inspection.

Prior to the start of a MATCH, any ROBOT which is unable or ineligible to participate in that MATCH, as determined by the FTA, LRI, or Head REFEREE, is declared to be BYPASSED and is DISABLED. A team whose ROBOT is BYPASSED remains eligible to receive Qualification Ranking Points or Playoff MATCH points provided that its ROBOT has passed inspection, per [1102](#).

An [Inspection Checklist](#) is available to help teams self-inspect their ROBOT before their event. Teams are strongly encouraged to self-inspect prior to their event.

### 10.1 Rules

**1101** **\*It's your team's ROBOT.** The ROBOT and its MAJOR MECHANISMS must be built by the FIRST Robotics Competition team.

A MAJOR MECHANISM is a group of COMPONENTS and/or MECHANISMS assembled together to address at least 1 game challenge: ROBOT movement, GAME PIECES manipulation, FIELD element manipulation, or performance of a scorable task without the assistance of another ROBOT.

This rule requires that the ROBOT and its MAJOR MECHANISMS were built by its team, but isn't intended to prohibit or discourage assistance from other teams (e.g. fabricating elements, supporting construction, writing software, developing game strategy, contributing COMPONENTS and/or MECHANISMS, etc.)

Examples of MAJOR MECHANISMS include, but are not limited to, assemblies used to:

- a. manipulate GAME PIECES,

- b. manipulate a FIELD element, and
- c. move the ROBOT around the FIELD.

Examples that would generally not be considered MAJOR MECHANISMS, and thus probably aren't subject to this rule include, but are not limited to, the following:

- a. a gearbox assembly,
- b. a COMPONENT or MECHANISM that's part of a MAJOR MECHANISM, and
- c. COTS items.

Neither this rule nor the language in this blue box define specific thresholds for how much of a MAJOR MECHANISM must be the result of the team's effort. This rule expects and requires the team's honest assessment of whether they built the MAJOR MECHANISMS of their ROBOT.

Attempts to exploit loopholes in the definition of MAJOR MECHANISM in order to bypass this requirement are in the spirit of neither this rule nor the FIRST Robotics Competition. Examples of exploitation include:

- a. assembling pieces of a MAJOR MECHANISM provided by another team, except COTS kits and
- b. receiving a mostly complete MAJOR MECHANISM from another team and providing a small piece.

- I102 \*Get inspected before playing a Qualification/Playoff MATCH.** A team is only permitted to participate in a Qualification or Playoff MATCH and receive Ranking or MATCH Points if their ROBOT has passed an initial, complete inspection.

*Violation: If prior to the start of the MATCH, the team is DISQUALIFIED and not eligible to participate in the MATCH. If after the start of the MATCH, the entire ALLIANCE receives a RED CARD for that MATCH.*

Please take note of this rule. It is important that FIRST Robotics Competition teams ensure their ALLIANCE partners have passed inspection. Allowing a partner that has not passed inspection to play puts the ALLIANCE at risk of RED CARDS. Teams should check with their ALLIANCE partners early and help them pass inspection before competing.

- I103 \*Bring it all to inspection.** At the time of inspection, the OPERATOR CONSOLE and the ROBOT must be presented with all MECHANISMS (including all COMPONENTS of each MECHANISM), configurations, and decorations that will be used on the ROBOT in MATCHES without re-inspection (per [I104](#)) and may not exceed 150 lbs. (~68 kg) (note that while up to 150 lbs. (~68 kg) of ROBOT MECHANISMS may be inspected together, the ROBOT configuration used in a MATCH may not violate [R103](#)). The OPERATOR CONSOLE and exceptions listed in [R103](#) are not included in this weight.

- I104 \*Unless the change is listed below, any change to a ROBOT must get re-inspected.** A ROBOT may play MATCHES with a subset of the MECHANISMS that were present during inspection provided the reconfigured ROBOT still complies with all ROBOT Construction Rules. Only MECHANISMS that were present during the inspection may be added, removed, or reconfigured between MATCHES without re-inspection per this rule. If a ROBOT is modified after its most recent passed inspection, it must be re-inspected before it is eligible to participate in a MATCH. A ROBOT that plays in a MATCH with an un-inspected modification may be retro-actively DISQUALIFIED at the discretion of the LRI and Head REFEREE.

Exceptions are listed in [A](#) through [E](#) (unless they result in a significant change to the ROBOT'S size, weight, legality, or safety).

- A. addition, relocation, or removal of fasteners (e.g. cable ties, tape, and rivets),
- B. addition, relocation, or removal of labeling or marking,
- C. revision of ROBOT code,
- D. replacement of a COTS COMPONENT with an identical COTS COMPONENT,
- E. replacement of a MECHANISM with an identical MECHANISM (size, weight, material), and
- F. additions, removals, or reconfiguration of ROBOT with a subset of MECHANISMS already inspected per [I103](#).

**I105** **\*Don't exploit re-inspection.** Teams may not use the re-inspection process in [I104](#) to circumvent the weight limit in [I103](#).

This restriction is not intended to prevent a team from returning to a previous configuration (e.g. due to an unsuccessful upgrade or failure of a new COMPONENT). If a team is believed to be violating this rule, the LRI will discuss the situation with the team to understand the changes and, if appropriate, the LRI in conjunction with the team will select a single configuration with which the team will compete for the duration of the event.

Example 1: A ROBOT passes initial inspection (which includes MECHANISM A). Its team then decides they want to use MECHANISM B, which was not inspected. The weight of the ROBOT, A, and B is less than the weight limit in [I103](#), but more than that in [R103](#). [I104](#) requires the ROBOT be re-inspected, and this rule allows the ROBOT, A, and B to be inspected collectively. If passed, the ROBOT may then compete in subsequent MATCHES with A or B.

Example 2: A ROBOT passes initial inspection (which includes MECHANISM A). Its team then decides they want to use MECHANISM B, which was not inspected. The weight of the ROBOT, A, and B is greater than the weight limit in [I103](#). This requires re-inspection per [I104](#) and A is excluded to satisfy [I103](#). B breaks, and the team decides to switch back to A. The ROBOT must be re-inspected per [I104](#), and the team is not violating this rule.

Example 3: A team arrives at an event with a ROBOT, MECHANISM A, and MECHANISM B, which collectively weigh 175 lbs (79 kg). The ROBOT passes initial inspection with A and plays a MATCH. The team switches to B, gets re-inspected, and plays again. The team switches back to A, gets re-inspected, and plays again. The team switches back to B and asks to be re-inspected. At this point, the LRI suspects the team may be violating this rule and has a discussion with the team to understand the changes being made. The team reveals that this rule has been violated, and the LRI works with them to select A or B for use for the remainder of the event.

**I106** **\*ROBOTS are off for inspection (mostly).** For the safety of all those involved, ROBOTS, must be presented for inspection with the ROBOT powered off, pneumatics unpressurized, and springs or other stored energy devices in their lowest potential energy states (e.g. battery removed).

Power and air pressure should only be enabled on the ROBOT during those portions of the inspection process where it is absolutely required to validate certain system functionality and compliance with specific rules (firmware check, etc.). INSPECTORS may allow the ROBOT to be powered beyond the parameters above if both criteria below are met:

- A. the ROBOT design requires power or a charged stored energy device in order to confirm that the ROBOT meets volume requirements and



- 
- B. the team has included safety interlocks that mitigate unexpected release of such stored energy.

The team may be asked to demonstrate these interlocks during the inspection process.

- I107** \*No STUDENT, no inspection. At least 1 STUDENT team member must accompany the ROBOT for any inspection efforts.

Exceptions may be made for major conflicts, e.g. religious holidays, major testing, transportation issues, etc.



## 11 TOURNAMENTS

Each 2023 FIRST® Robotics Competition event is played in a tournament format. Each tournament consists of 3 types of MATCHES: Practice MATCHES (not necessarily played at all District Events), Qualification MATCHES, and Playoff MATCHES.

Practice MATCHES provide each team with an opportunity to operate its ROBOT on the FIELD prior to the start of the Qualification MATCHES.

Qualification MATCHES allow each team to earn Ranking Points which determine their seeding position and may qualify them for participation in the Playoff MATCHES.

Playoff MATCHES determine the event Champions.

### 11.1 MATCH Schedules

A MATCH schedule is used to coordinate MATCHES at an Event. Figure 11-1 details information shown on each schedule. SURROGATE MATCHES are described in [Section 11.6.2 MATCH Assignment](#).

Figure 11-1 Sample MATCH schedule

**Qualification Match Schedule**

Matches Per Team		10	Event Name					
Time	Description	Match	Blue 1	Blue 2	Blue 3	Red 1	Red 2	Red 3
Thu 2:30	Qualification 1	1	1	2	3	4	5	6
Thu 2:37	Qualification 2	2	7	8	9	10	11*	12
Thu 2:44	Qualification 3	3	13	14	15*	16	17	18

ALLIANCE Red or Blue (points to Red 1 column)  
 DRIVER STATION number 1, 2, or 3 (points to Red 2 column)  
 MATCH Start Time (points to Thu 2:30)  
 MATCH Type (points to Qualification 1)  
 MATCH Number (points to 1)  
 Asterisk (\*) indicates SURROGATE MATCH (points to 11\* and 15\*)

### 11.2 Head REFEREE and FTA Interaction

The Head REFEREE has the ultimate authority in the ARENA during the event, but may receive input from additional sources, e.g. Game Designers, FIRST personnel, FTA, and other event staff. The Head REFEREE rulings are final. No event staff, including the Head REFEREE, will review video, photos, artistic renderings, etc. of any MATCH, from any source, under any circumstances.

#### 11.2.1 Question Box

Each ALLIANCE has a designated Question Box near the scoring table. If a DRIVE TEAM has a question about a MATCH, the FIELD, etc., they may send 1 DRIVE TEAM member to their corresponding Question Box. Depending on timing, the Head Referee or FTA may postpone any requested discussion until the end of the subsequent MATCH as necessary.

Technical questions regarding FIELD or ROBOT operation are addressed by the FTA, additional team members are invited to participate in these conversations if necessary. If a DRIVE TEAM needs clarification on a ruling or score, per H202, 1 STUDENT from that DRIVE TEAM should address the Head REFEREE after the ARENA Reset Signal (e.g. FIELD lights turn green).

While FMS tracks quantities of FOULS, *FIRST* instructs REFEREES to not self-track details about FOULS and TECH FOULS; as a result, we don't expect REFEREES to recall details about what FOULS and TECH FOULS were made, when they occurred, and against whom.

Any reasonable question is fair game in the Question Box, and Head REFEREES will make good faith efforts to provide helpful feedback (e.g. how/why certain FOULS are being called, why a particular ROBOT may be susceptible to certain FOULS based on its design or game play, how specific rules are being called or interpreted), but please know that they may not be able to supply specific details.

### 11.2.2 YELLOW and RED CARDS

In addition to rule violations explicitly listed throughout the *2023 Game Manual*, YELLOW CARDS and RED CARDS are used in *FIRST* Robotics Competition to address team and ROBOT behavior that does not align with the mission, values, and culture of *FIRST*.

As noted in [Section 6.5 Rule Violations](#) and [H201](#), the Head REFEREE may assign a YELLOW CARD as a warning, or a RED CARD for DISQUALIFICATION in MATCH for egregious behavior inappropriate at a *FIRST* Robotics Competition event.

A YELLOW or RED CARD is indicated by the Head REFEREE holding a YELLOW and/or RED CARD in the air while the Game Announcer describes the violation.

Per [Section 6.5 Rule Violations](#) YELLOW CARDS are additive, meaning that a second YELLOW CARD is automatically converted to a RED CARD. A team is issued a RED CARD for any subsequent incident in which they receive an additional YELLOW CARD, including earning a second YELLOW CARD during a single MATCH. A second YELLOW CARD is indicated by the Head REFEREE standing in front of the team's DRIVER STATION and holding a YELLOW CARD and RED CARD in the air simultaneously after the completion of the MATCH. A team that has received either a YELLOW CARD or a RED CARD carries a YELLOW CARD into subsequent MATCHES, except as noted below.

Once a team receives a YELLOW or RED CARD, its team number is presented with a yellow background on the audience screen at the beginning of all subsequent MATCHES, including any replays, as a reminder to the team, the REFEREES, and the audience that they carry a YELLOW CARD.

Figure 11-2 Example audience screen graphic showing YELLOW CARD indicators

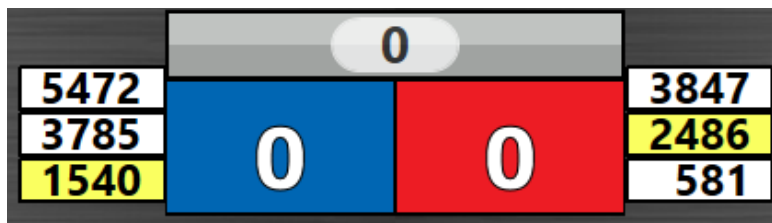

All YELLOW CARDS are cleared in FMS at the conclusion of Practice, Qualification, and division Playoff MATCHES. Verbal warnings are cleared after Practice MATCHES and persist from Qualification MATCHES through subsequent tournament phases. The Head REFEREE may opt to perpetuate a verbal warning or YELLOW CARD earned during Practice MATCHES through to Qualification MATCHES for particularly egregious behavior.

### 11.2.3 YELLOW and RED CARD application

YELLOW and RED CARDS are applied based on the following:

Table 11-1 YELLOW and RED CARD application

Time YELLOW or RED CARDS earned:	MATCH to which CARD is applied:
prior to Practice MATCHES	Team's first Practice MATCH
during the Practice MATCHES	Team's current (or just-completed) MATCH.
between the end of PRACTICE MATCHES and the start of Qualification MATCHES	Team's first Qualification MATCH
during the Qualification MATCHES	Team's current (or just-completed) MATCH. In the case where the team participated as a SURROGATE in the current (or just completed) MATCH, the card is applied to the team's previous MATCH (i.e. the team's second Qualification MATCH)
between the end of Qualification MATCHES and the start of Playoff MATCHES	ALLIANCE'S first Playoff MATCH
during the Playoff MATCHES	ALLIANCE'S current (or just-completed) MATCH

Please see examples of the application of YELLOW and RED CARDS as shown in [Section 6.5.1 Violation Details](#).

### 11.2.4 YELLOW and RED CARDS during Playoff MATCHES

During Playoff MATCHES, YELLOW and RED CARDS are assigned to the violating team's entire ALLIANCE instead of to only the violating team. If an ALLIANCE receives 2 YELLOW CARDS, the entire ALLIANCE is issued a RED CARD which results in DISQUALIFICATION for the associated MATCH. If both ALLIANCES receive a RED CARD, the ALLIANCE assessed the first RED CARD, chronologically, is DISQUALIFIED and loses the MATCH.

## 11.3 MATCH Replays

Over the course of the tournament, it may be necessary for a MATCH to be replayed. Typical causes for replays are MATCHES that end in a tie during the Playoffs, MATCHES that are stopped because FIELD STAFF anticipated FIELD damage or personal injury, or if there is an ARENA FAULT. An ARENA FAULT is an error in ARENA operation that includes, but is not limited to:

- A. broken FIELD elements due to
  - a. normal, expected game play or
  - b. ROBOT abuse of FIELD elements that affects the outcome of the MATCH for their opponents,

A broken FIELD element caused by ROBOT abuse that affects the outcome of the MATCH for their ALLIANCE is not an ARENA FAULT.

- B. power failure to a portion of the FIELD (tripping the circuit breaker in the DRIVER STATION is not considered a power failure),
- C. improper activation by the FMS, and
- D. errors by FIELD STAFF (except those listed in Other Logistics).

If, in the judgment of the Head REFEREE, an ARENA FAULT occurs that affects the outcome of the MATCH and any team on the affected ALLIANCE desires a replay, the MATCH will be replayed. *FIRST* Headquarters reserves the right to, with consultation of the Head REFEREE and the FTA, replay a MATCH in which an ARENA FAULT impacts the outcome of an event.

The outcome of the MATCH is affected if an error occurs that, in the judgement of the Head REFEREE, changes which ALLIANCE would have won the MATCH and/or the assignment of Ranking Points.

The outcome of an event is affected if an error occurs that, in the judgement of *FIRST* Headquarters, changes the assignment of Ranking Points or has a dramatic effect on points used for ranking criteria.

Note that an ARENA FAULT that does not affect MATCH outcome, in the judgement of the Head REFEREE, does not lead to a MATCH replay. Examples include, but are not limited to:

- c. a piece of FIELD plastic falls into the FIELD, far away from any human or ROBOT activity, and in such a way that it does not affect MATCH outcome,
- d. delay in the playing of an ARENA sound,
- e. mismatch between the timer on the audience screen and the ARENA timer, and
- f. any adjustment or delay in assignment of a penalty (including those made after the MATCH).

**T301** **\*Replays will be the same.** All reasonable effort is made to create the same conditions when replaying a MATCH caused by an ARENA FAULT or FIELD damage. This means, for example, that a team that was BYPASSED prior to the start of the MATCH which is to be replayed is BYPASSED for the replay MATCH. ROBOT and DRIVE TEAM starting locations do not need to be replicated when replaying a MATCH.

*Violation: MATCH with not start until the situation is corrected*

## 11.4 Measurement

At each event, the ARENA will be open for at least 30 minutes prior to the start of Qualification MATCHES, during which time teams may survey and/or measure the ARENA and bring ROBOTS on the FIELD to perform sensor calibration. The specific time that the FIELD is open will be communicated to teams at the event. Teams may bring specific questions or comments to the FTA.

**T401** **\*Freeze, ROBOT.** During the period when the ARENA is open for measurement, ROBOTS can be enabled, but may neither drive, extend outside their FRAME PERIMETER, nor interact with (e.g. score, push, pickup, etc.) GAME PIECES, the CHARGE STATION, GRIDS, or other FIELD elements.

*Violation: Verbal warning. If subsequent violations at any point during the event or egregious YELLOW CARD.*

## 11.5 Practice MATCHES

Practice MATCHES are played before Qualification MATCHES. The Practice MATCH schedule is available as soon as possible, but no later than the start of Practice MATCHES. For Regional events, it will also be published and available online at the [FIRST Robotics Event Results site](#), except during exceptional circumstances. Practice MATCHES are randomly assigned, and teams may not switch scheduled Practice MATCHES. Each team is assigned an equal number of Practice MATCHES unless the number of

---

teams multiplied by number of Practice MATCHES is not divisible by 6. In this case, the FMS randomly selects some teams to play an extra Practice MATCH.

Practice MATCHES are not guaranteed at District Events due to event schedule constraints.

---

### 11.5.1 Filler Line

A Filler Line is used to fill open slots at events that employ scheduled Practice MATCHES or all slots at events with an open Practice MATCH schedule. Teams from the Filler Line are used on a first come, first served basis to fill empty spots in Practice MATCHES left by other teams that do not report to Queuing. The number of teams in the Filler Line is dependent upon space at venues.

Only teams that meet all criteria below qualify for the Filler Line:

- A. ROBOTS in the Filler Line must have passed inspection (this requirement may be waived for events with open Practice MATCH schedules),
- B. DRIVE TEAMS must join the Filler Line with their ROBOT,
- C. teams may not work on their ROBOT while in the Filler Line,
- D. teams may not occupy more than 1 spot in the Filler Line, and
- E. if a team is queued for their Practice MATCH, they may not also join the Filler Line.

---

## 11.6 Qualification MATCHES

---

### 11.6.1 Schedule

The Qualification MATCH schedule is made available as soon as possible, but no later than 30 minutes before Qualification MATCHES are scheduled to begin. Teams receive 1 hard copy and it is also available at the [FIRST Robotics Competition Event Results site](#), except during exceptional circumstances. Each Qualification schedule consists of a series of rounds in which each team plays 1 MATCH per round.

---

### 11.6.2 MATCH Assignment

FMS assigns each team 2 ALLIANCE partners for each Qualification MATCH using a predefined algorithm, and teams may not switch Qualification MATCH assignments. The algorithm employs the following criteria, listed in order of priority:

1. maximize time between each MATCH played for all teams
2. minimize the number of times a team plays opposite any team
3. minimize the number of times a team is allied with any team
4. minimize the use of SURROGATES (teams randomly assigned by the FMS to play an extra Qualification MATCH)
5. provide even distribution of MATCHES played on blue and red ALLIANCE
6. provide even distribution of MATCHES played in each DRIVER STATION number

At events with fewer than 24 participating teams, the criteria are similar, however criterion 5 is changed to minimize the number of times a team swaps between the blue and red ALLIANCE rather than an even distribution.

All teams are assigned the same number of Qualification MATCHES, equal to the number of rounds, unless the number of teams multiplied by number of MATCHES is not divisible by 6. In this case, the FMS randomly selects some teams to play an extra MATCH. For the purpose of seeding calculations, those teams are designated as SURROGATES for the extra MATCH. If a team plays a MATCH as a SURROGATE, it is indicated on the MATCH schedule, it is always their third Qualification MATCH, and the outcome of



the MATCH has no effect on the team’s ranking. YELLOW and RED CARDS assigned to SURROGATES, however, do carry forward to subsequent MATCHES.

### 11.6.3 Qualification Ranking

Ranking Points are units credited to a team based on their ALLIANCE’S performance in Qualification MATCHES. Ranking Points are awarded to each eligible team at the completion of each Qualification MATCH per Table 6-1.

Exceptions to Ranking Point assignment are as follows:

- A. A SURROGATE receives 0 Ranking Points.
- B. A DISQUALIFIED team, as determined by the Head REFEREE, receives 0 Ranking Points in a Qualification MATCH or causes their ALLIANCE to receive 0 MATCH points in a Playoff MATCH.
- C. A “no-show” team is either DISQUALIFIED from or issued a RED CARD for that MATCH (see [H305](#)). A team is declared a no-show if no member of the DRIVE TEAM is in the ALLIANCE AREA at the start of the MATCH.

The total number of Ranking Points earned by a team throughout their Qualification MATCHES divided by the number of MATCHES they’ve been scheduled to play (minus any SURROGATE MATCH), then truncated to 2 decimal places, is their Ranking Score (RS).

All teams participating in Qualification MATCHES are ranked by Ranking Score. If the number of teams in attendance is ‘n’, they are ranked ‘1’ through ‘n’, with ‘1’ being the team with the highest Ranking Score and ‘n’ being the team with the lowest Ranking Score.

Teams are ranked in order, using the sorting criteria defined in Table 11-2.

*Table 11-2 Qualification MATCH ranking criteria*

Order Sort	Criteria
1 <sup>st</sup>	Ranking Score
2 <sup>nd</sup>	Average ALLIANCE MATCH points, not including FOULS
3 <sup>rd</sup>	Average ALLIANCE CHARGE STATION points
4 <sup>th</sup>	Average ALLIANCE AUTO points
5 <sup>th</sup>	Random sorting by the FMS

## 11.7 Playoff MATCHES

Playoff MATCHES follow the qualification MATCHES. In the Playoffs, teams play on set ALLIANCES, chosen during ALLIANCE selection, and advance through a double elimination bracket. Teams do not earn Ranking Points; they advance based on winning, losing, or tying a MATCH.

### 11.7.1 ALLIANCE Selection Process

At the end of the Qualification MATCHES, the top 8 ranked teams become the ALLIANCE Leads. The ranked ALLIANCES are designated, in order, ALLIANCE 1, ALLIANCE 2, etc., down to ALLIANCE 8. Using

the ALLIANCE selection process described in this section, each ALLIANCE Lead chooses 2 other teams to join their ALLIANCE.

**T701 \*Send a STUDENT representative.** Each team must choose and send a STUDENT team representative to the ARENA at the designated ALLIANCE Selection time (typically before the lunch break on the final day of the event) to represent their team. The designated STUDENT representative from each ALLIANCE Lead is called the ALLIANCE CAPTAIN. This representative may change between ALLIANCE selection and PLAYOFF MATCHES.

*Violation: Team is ineligible for the Playoff Tournament*

If an absent team would have been an ALLIANCE Lead, all lower ranked ALLIANCE Leads are promoted 1 spot. The next highest-ranked team moves up to become the ALLIANCE 8 Lead.

The ALLIANCE selection process consists of 2 rounds during which each ALLIANCE CAPTAIN invites a team ranked below them in the standings to join their ALLIANCE.

Round 1: In descending order (ALLIANCE 1 to ALLIANCE 8), each ALLIANCE CAPTAIN invites a single team to join their ALLIANCE. The invited team's representative steps forward and either accepts or declines the invitation.

If the team accepts, it becomes a member of that ALLIANCE. If an invitation from a top 8 ALLIANCE to another ALLIANCE Lead is accepted, all lower ALLIANCE Leads are promoted 1 spot. The highest-ranked, unselected team becomes the ALLIANCE 8 Lead.

Round 2: The same method is used for each ALLIANCE CAPTAIN'S second choice except the selection order is reversed, with ALLIANCE 8 picking first and ALLIANCE 1 picking last. This process results in 8 ALLIANCES of 3 teams.

**T702 \*Declining teams can't be picked.** An ALLIANCE CAPTAIN may not invite a team that has declined another ALLIANCE'S invitation to participate in the Playoff tournament. Declining teams are ineligible to be a BACKUP TEAM.

*Violation: The ALLIANCE CAPTAIN must make another selection*

An ALLIANCE Lead that declines an invitation from another ALLIANCE is able to invite teams to join their ALLIANCE but may not be invited to join another ALLIANCE.

At the conclusion of ALLIANCE selection, the highest ranked unselected teams are eligible to become a BACKUP TEAM, as defined in [Section 11.7.3 BACKUP TEAMS](#).

---

## 11.7.2 Playoff MATCH Bracket

The double elimination tournament consists of an Upper and Lower bracket as shown in Figure 11-3. Each ALLIANCE begins with a slot in the Upper bracket. If an ALLIANCE wins a MATCH in the Upper bracket, they remain in the Upper bracket. If an ALLIANCE loses a MATCH in the Upper bracket, they transition to the Lower bracket. ALLIANCES in the Lower bracket must win any subsequent MATCHES (except for finals) to remain in the tournament, i.e. once they lose a MATCH, they're out of the tournament.

In Round 1, the higher ranked ALLIANCE is assigned to the red ALLIANCE. For subsequent rounds, ALLIANCE color is assigned as shown in Figure 11-3, regardless of ALLIANCE rank at the start of the Playoff tournament.

Figure 11-3 Playoff MATCH bracket (Red ALLIANCE tops each pairing)

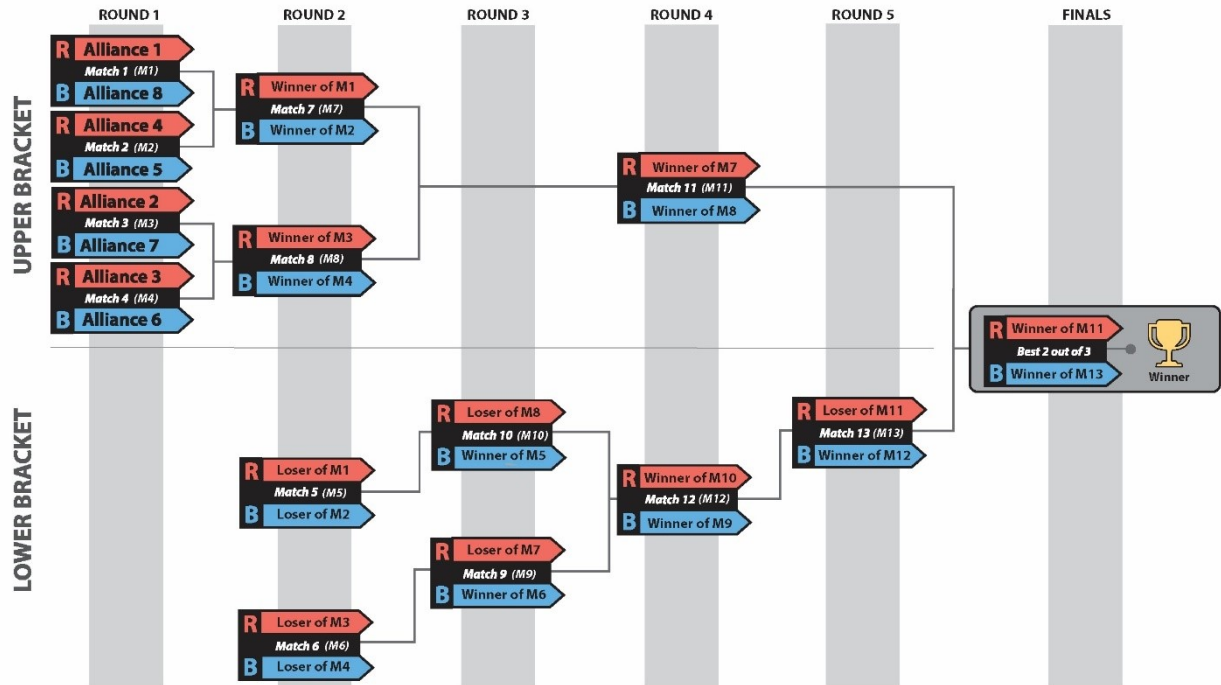

As shown in Figure 11-3 and Table 11-3, Playoff MATCHES consist of 6 rounds with breaks between rounds and between the Finals MATCHES. Breaks begin after the FIELD has been cleared from the previous MATCH. The Blue and Red Gap columns indicate the approximate time between each ALLIANCE'S MATCHES. The expected start time of the MATCH is the time indicated on the MATCH schedule or 15 minutes from the end of either ALLIANCE'S previous MATCH, whichever is later.

Table 11-3 Typical Playoff MATCH Schedule

MATCH	Blue	Red	Blue Gap (minutes)	Red Gap (minutes)	Winner moves to	Loser moves to
Upper Bracket – Round 1 – MATCH 1	ALLIANCE 8	ALLIANCE 1			Red – MATCH 7	Red – MATCH 5
Upper Bracket – Round 1 – MATCH 2	ALLIANCE 5	ALLIANCE 4			Blue – MATCH 7	Blue – MATCH 5
Upper Bracket – Round 1 – MATCH 3	ALLIANCE 7	ALLIANCE 2			Red – MATCH 8	Red – MATCH 6
Upper Bracket – Round 1 – MATCH 4	ALLIANCE 6	ALLIANCE 3			Blue – MATCH 8	Blue – MATCH 6
<b>8-minute Break</b>						
Lower Bracket – Round 2 – MATCH 5	Loser of MATCH 2	Loser of MATCH 1	24m	31m	Blue – MATCH 10	
Lower Bracket – Round 2 - MATCH 6	Loser of MATCH 4	Loser of MATCH 3	17m	24m	Blue – MATCH 9	
Upper Bracket – Round 2 - MATCH 7	Winner of MATCH 2	Winner of MATCH 1	38m	45m	Red – MATCH 11	Red – MATCH 9
Upper Bracket – Round 2 - MATCH 8	Winner of MATCH 4	Winner of MATCH 3	31m	38m	Blue – MATCH 11	Red – MATCH 10
<b>8-minute Break</b>						

Lower Bracket – Round 3 - MATCH 9	Winner of MATCH 6	Loser of MATCH 7	24m	17m	Red – MATCH 12	
Lower Bracket – Round 3 - MATCH 10	Winner of MATCH 5	Loser of MATCH 8	38m	17m	Blue – MATCH 12	
<b>8-minute Break</b>						
Upper Bracket – Round 4 - MATCH 11	Winner of MATCH 8	Winner of MATCH 7	30m	37m	Red – Match 14	Red – MATCH 13
Lower Bracket – Round 4 - MATCH 12	Winner of MATCH 10	Winner of MATCH 9	17m	24m	Blue – MATCH 13	
<b>15-minute Awards Break</b>						
Lower Bracket – Round 5 - MATCH 13	Winner of MATCH 12	Loser of MATCH 11	24m	17m	Blue – MATCH 14	
<b>15-minute Awards Break</b>						
Finals – Match 14	Winner of MATCH 13	Winner of MATCH 11	17m	37m	MATCH 15	MATCH 15
<b>15-minute Awards Break</b>						
Finals – Match 15	Winner of MATCH 13	Winner of MATCH 11	17m	17m	MATCH 16*	MATCH 16*
<b>15-minute Awards Break *</b>						
Finals – Match 16 *	Winner of MATCH 13	Winner of MATCH 11	17m	17m		

\* if required

#### 11.7.2.1 Playoff MATCH ties

If final MATCH scores for both ALLIANCES are equal, the win is awarded to the ALLIANCE per criteria listed in Table 11-4.

Table 11-4 Playoff MATCH Tiebreaker Criteria

Order Sort	Criteria
1 <sup>st</sup>	Cumulative TECH FOUL points due to opponent rule violations
2 <sup>nd</sup>	ALLIANCE CHARGE STATION points
3 <sup>rd</sup>	ALLIANCE AUTO points
4 <sup>th</sup>	MATCH is replayed

#### 11.7.2.2 Playoff Finals

Once a single ALLIANCE remains in each Upper and Lower bracket, those ALLIANCES proceed to the Finals round. The first ALLIANCE to win 2 MATCHES in the Finals becomes the event’s Champions.

If a Finals MATCH ends in a tie score, the tie is not broken using the criteria in Table 11-4, the MATCH remains a tie. In the case where an ALLIANCE hasn’t won 2 MATCHES after 3 MATCHES have been played (because of tied MATCHES), the Playoffs proceed with up to 3 additional Finals MATCHES, called Overtime MATCHES, until an ALLIANCE has won 2 Finals MATCHES. In the case where the Overtime MATCH scores for both ALLIANCES are equal, the win for that Overtime MATCH is awarded based on the criteria listed in Table 11-4.

If a Playoff MATCH needs to be replayed as described in [Section 11.3 MATCH Replays](#), teams are notified of when the replay will occur. A minimum 10-minute delay is provided for teams to reset their ROBOTS

prior to the replay unless all teams are ready sooner. The affected MATCH must be replayed before the next round begins.

### 11.7.3 BACKUP TEAMS

During the Playoff MATCHES an ALLIANCE may elect to replace one of its ROBOTS due to a mechanical or software issue that prevents that ROBOT from competing effectively. The team whose ROBOT and DRIVE TEAM replaces another ROBOT and DRIVE TEAM on an ALLIANCE during the Playoff MATCHES is called the BACKUP TEAM.

In this situation, the ALLIANCE CAPTAIN has the option to bring in the highest ranked team from the pool of available teams to join its ALLIANCE for the following MATCH. The resulting ALLIANCE is then composed of 4 teams.

ALLIANCES submit LINEUPS (as described in [Section 11.7.4 LINEUPS](#)) for each Playoff MATCH. After the BACKUP TEAM'S first Playoff MATCH, the ALLIANCE'S LINEUP may consist of any 3 of the ALLIANCE'S 4 teams.

#### 11.7.3.1 BACKUP TEAM Coupons

Each ALLIANCE is allotted 1 BACKUP TEAM coupon during the Playoff MATCHES. If a second ROBOT from the ALLIANCE becomes inoperable, then the ALLIANCE must play the following MATCHES with only 2 (or even 1) ROBOTS.

Example: 3 teams, A, B and C, form an ALLIANCE going into the Playoff MATCHES. The highest ranked team not on 1 of the 8 ALLIANCES is Team D. During 1 of the Playoff MATCHES, Team C's ROBOT suffers damage to its mechanical arm. The ALLIANCE CAPTAIN decides to bring in Team D to replace Team C in the next MATCH. The new ALLIANCE of Teams A, B, C, and D are successful in advancing to the Finals and win the event. Teams A, B, C, and D are all recognized as members of the Winning ALLIANCE and receive awards.

The Head REFEREE will not accept the BACKUP TEAM coupon unless it is initialed by the ALLIANCE CAPTAIN. Once a BACKUP TEAM coupon is submitted and accepted by the Head REFEREE, the BACKUP TEAM coupon may not be withdrawn by the ALLIANCE.

**T703 \*No BACKUP TEAM for replayed MATCHES.** An ALLIANCE may not request a BACKUP TEAM for a replayed MATCH. The sole exception is if, in the judgment of the Head REFEREE, the replay is due to an ARENA FAULT that rendered an ALLIANCE'S ROBOT inoperable.

*Violation: The request is denied.*

**T704 \*No BACKUP TEAMS for 1st match.** An ALLIANCE may not request a BACKUP TEAM until after their first Playoff MATCH.

*Violation: The request is denied.*

**T705 \*BACKUP TEAMS play when called.** A BACKUP TEAM must be included in the LINEUP for the ALLIANCE'S next MATCH following their recruitment.

*Violation: The LINEUP is denied.*

If the Head REFEREE is busy, and there is no designee, the ALLIANCE CAPTAIN remains in the Question Box to report the LINEUP.

**T706 \*BACKUP TEAMS due 2 minutes before the MATCH start time.** The BACKUP TEAM Coupon must be submitted to the Head REFEREE (or their designee) 2 minutes before the expected MATCH start time in which the BACKUP TEAM is to play.

*Violation: The request is denied*

If the Head REFEREE is busy, and there is no designee, the ALLIANCE CAPTAIN remains in the Question Box to submit the BACKUP TEAM coupon.

#### 11.7.3.2 BACKUP POOL

After the top ranked ALLIANCE has made their final pick during ALLIANCE Selection, REFEREES poll the remaining eligible teams. In rank order, REFEREES invite remaining teams to accept or decline a position in the BACKUP POOL, i.e. the group of teams willing and able to join an ALLIANCE during the Playoff MATCHES, if needed, until up to 8 teams accept.

**T707 \*Be there to be a BACKUP TEAM.** A team must be present after ALLIANCE Selection to accept the REFEREE'S invitation to join the BACKUP POOL.

*Violation: Team is ineligible to be a BACKUP TEAM.*

**T708 \*Send a BACKUP TEAM Representative.** The top 2 ranked BACKUP TEAMS must send at least 1 STUDENT representative (and optionally 1 additional STUDENT or mentor) to a designated area near the FIELD for the duration of the Playoff MATCHES.

These 2 representatives are available to answer questions and accept invitations to be a BACKUP TEAM from ALLIANCE CAPTAINS. If 1 of these 2 teams joins an ALLIANCE or excuses themselves from the BACKUP POOL, the next highest ranked team in the BACKUP POOL must provide their representative. Once a BACKUP TEAM has declined an invitation to join an ALLIANCE, it is no longer a member of the BACKUP POOL and ineligible to join another ALLIANCE.

*Violation: Verbal warning. If situation cannot be corrected within a reasonable amount of time, the team is removed from BACKUP POOL.*

Some events may offer an area near the FIELD where the top 1 or 2 teams in the BACKUP POOL may choose to stage their ROBOT for quick and easy access to the FIELD if recruited.

#### 11.7.4 LINEUPS

Each ALLIANCE competing in a Playoff MATCH has the option to submit a LINEUP, which lists the 3 teams participating in the MATCH and their selected DRIVER STATIONS.

The LINEUP is kept confidential until the FIELD is set for the MATCH at which point each ALLIANCE'S LINEUP appears on the Team Signs.

##### 11.7.4.1 LINEUPS for 4-team ALLIANCES

If an ALLIANCE has 4 members (either because a 3-team ALLIANCE has called a BACKUP TEAM or the event is the FIRST Championship), a single representative from the team not on the LINEUP is allowed as a sixteenth ALLIANCE member but must be a member of that team's DRIVE TEAM. This additional representative may only serve as a COACH.

##### 11.7.4.2 Default LINEUP



**T709** \***LINEUPS due 2 minutes before the MATCH.** The ALLIANCE CAPTAIN must submit their LINEUP in writing to the Head REFEREE (or their designee) 2 minutes before their expected MATCH start time.

*Violation: Late LINEUPS are denied, and the ALLIANCE'S most recent LINEUP is applied.*

If the Head REFEREE is busy, and there is no designee, the ALLIANCE CAPTAIN remains in the Question Box to report the LINEUP.

If no previous LINEUP exists, the ALLIANCE Lead is assigned DRIVER STATION 2, 1<sup>st</sup> team selected is assigned DRIVER STATION 1, and the 2<sup>nd</sup> team selected is assigned DRIVER STATION 3. If any of these 3 ROBOTS are unable to play, the ALLIANCE must play the MATCH with only 2 (or even 1) ROBOT(s).

**Example:** 3 teams, A, B, and C form an ALLIANCE going into the Playoff MATCHES. During one of the Playoff MATCHES, Team C's ROBOT becomes inoperable. The ALLIANCE decides to bring in Team D to replace Team C. Team C repairs their ROBOT and may play in any subsequent Playoff MATCHES replacing Team A, B, or D

**T710** \***For replays, no changing LINEUPS (mostly).** If a MATCH must be replayed due to an ARENA FAULT, the LINEUP for the replayed MATCH is the same as the original MATCH. The sole exception is if the ARENA FAULT rendered a ROBOT inoperable, in which case the LINEUP can be changed.

*Violation: The new LINEUP is denied.*

### 11.7.5 Pit Crews

During the Playoff MATCHES and because of the distance between the FIELD and the pit area, extra team members may be needed to maintain the ROBOT between MATCHES. Each team is permitted to have up to 3 additional pit crew members to help with needed ROBOT repairs/maintenance.

### 11.7.6 Small Event Exceptions

The scheduling algorithm described in [Section 11.6.2 MATCH Assignment](#) works to minimize teams playing in back-to-back MATCHES. However, at events with fewer than 24 teams, back-to-back plays may occur.

Multi-day events with 24 teams or fewer employ a modified Playoff MATCH format. Instead of 8 ALLIANCES, these events proceed through ALLIANCE SELECTION and the Playoff Tournament with the maximum number of complete 3-team ALLIANCES that can be formed while leaving at least 1 BACKUP TEAM (e.g. a 24-team event creates 7 ALLIANCES, a 20-team event creates 6 ALLIANCES).

$$ALLIANCE\ Count = \frac{Team\ count - 1\ BACKUP\ TEAM}{3}, rounded\ down$$

The Playoff Bracket remains as shown in Figure 11-3, with any matchup against a non-existent ALLIANCE resulting in a bye (i.e. automatic advancement to the next round). An ALLIANCE assigned a bye-MATCH is invited, though not required, to practice together in a null MATCH (i.e. it has no bearing on the Playoff tournament) during the designated time in the Playoff schedule.

District points for Draft Order Acceptance (per [Section 11.8.1.2 ALLIANCE Selection Results](#)) are awarded as if a full set of ALLIANCES was selected (i.e. the second selection of the 3-seed ALLIANCE still receive 3 points regardless of how many ALLIANCES are formed).

## 11.8 Advancement Through the District Model

Teams advance through the season depending on the events at which they compete: Regional or District. This section details how District teams advance from District qualifying events, to their District Championship.

### 11.8.1 District Events

District teams are ranked throughout the season based on the points they earn at their first 2 home District events they attend, as well as at their District Championship. Points are awarded to teams as follows:

Table 11-5 District Point Assignment

Category	Points
<b>Qualification Round Performance</b>	$\text{QualificationPoints}(R, N, \alpha) = \left[ \text{InvERF} \left( \frac{N - 2R + 2}{\alpha N} \right) \left( \frac{10}{\text{InvERF} \left( \frac{1}{\alpha} \right)} \right) + 12 \right]$ <p>(For a typically sized District event, this will result in a minimum of 4 points being awarded for Qualification round performance. For events of all sizes, a maximum of 22 points will be awarded.)</p>
<b>ALLIANCE CAPTAINS</b>	Equal to 17 minus the ALLIANCE CAPTAIN number (e.g. 14 points for ALLIANCE #3 Captain)
<b>Draft Order Acceptance</b>	Equal to 17 minus the Draft Order Acceptance Number (e.g. 12 points for the team that is fifth to accept an invitation)
<b>Playoff Advancement</b>	Points awarded based on team participation in individual playoff rounds, and whether or not the ALLIANCE advances. See <a href="#">Section 11.8.1.3 Playoff Round Performance</a> for details.
<b>Judged Team Awards</b>	<p>10 points for FIRST Impact Award (formerly the Chairman's Award)</p> <p>8 points each for Engineering Inspiration and Rookie All Star Awards</p> <p>5 points each for all other judged team awards</p>
<b>Team Age</b>	<p>10 points for 2023 rookie teams</p> <p>5 points for 2021 and 2022 rookie teams</p>

Points earned at District Championships are multiplied by 3 and then added to points earned at District events, to determine the final season point total for the team.

If there is a tie in the season point total between teams, those items are broken using the following sorting criteria:

Table 11-6 District team sort criteria

Order Sort	Criteria
1 <sup>st</sup>	Total Playoff Round Performance Points
2 <sup>nd</sup>	Best Playoff Round Finish at a single event
3 <sup>rd</sup>	Total ALLIANCE Selection Results Points
4 <sup>th</sup>	Highest Qualification Round Seed or Draft Order Acceptance (i.e. Highest ALLIANCE Selection points at a single event)
5 <sup>th</sup>	Total Qualification Round Performance Points
6 <sup>th</sup>	Highest Individual MATCH Score, regardless of whether that score occurred in a Qualification or Playoff MATCH
7 <sup>th</sup>	Second highest Individual MATCH Score, regardless of whether that score occurred in a Qualification or Playoff MATCH
8 <sup>th</sup>	Third highest Individual MATCH Score, regardless of whether that score occurred in a Qualification or Playoff MATCH
9 <sup>th</sup>	Random Selection

#### 11.8.1.1 Qualification Round Performance

The calculation of Qualification performance points is done using the equation (an inverse error function) in Table 11-5. The equation utilizes the following variables:

- R – the qualification rank of the team at the event at the conclusion of Qualification MATCHES (as reported by FMS)
- N – the number of FIRST Robotics Competition teams participating in the Qualification rounds at the event
- Alpha ( $\alpha$ ) – a static value (1.07) used to standardize the distribution of points at events

This formula generates an approximately normal distribution of Qualification Round Performance points at an event, based on rank, with most teams getting a moderate number of points, and fewer teams getting the highest or lowest numbers of points available.

Table 11-7 displays sample Qualification Round Performance points for variously ranked teams at a 40-team event. The system will automatically generate the appropriate points for each team based on their rank and the number of teams at the event.

Table 11-7 Sample Qualification Round point assignments

<b>Rank</b>	1	2	3	4	...	19	20	21	...	37	38	39	40
<b>Points</b>	22	21	20	19	...	13	13	12	...	6	6	5	4

#### 11.8.1.2 ALLIANCE Selection Results

This attribute measures both individual team qualification round seeding performance and recognition by peers.

ALLIANCE CAPTAINS are recognized based on their qualification round seeding rank. This rank is a result of the rules of the game, which typically incorporate several team performance attributes, and are designed to eliminate ties in rank. Non-ALLIANCE CAPTAINS are rewarded based on peer recognition. To be invited to join an ALLIANCE, a team’s peers have decided that the team has attributes that are desirable. Giving points for ALLIANCE selection also supports come-from-behind teams. A team taking several MATCHES to optimize their performance may be recognized as a late bloomer by a top seeded team, even if that performance isn’t reflected in the rankings because of poor performance in early MATCHES. These points also have the potential to recognize teams employing a minority strategy with their ROBOT. Teams with unique or divergent ROBOT capabilities that complement the strengths of other ALLIANCE members may be selected to fill a strategic niche.

Note also that ALLIANCE CAPTAINS are given the same number of points as the team drafted in the same sequence. For example, the third ALLIANCE CAPTAIN gets the same number of points as the third draft. Numerical analysis supports the idea that ALLIANCE CAPTAINS are about as strong in ROBOT performance as equivalently drafted teams. As an additional minor benefit, awarding the same points for ALLIANCE CAPTAINS and equivalent drafts lubricates the acceptance of draft offers between ALLIANCE CAPTAINS, which gives teams out of the top 8 the chance to experience being ALLIANCE CAPTAINS themselves.

### 11.8.1.3 *Playoff Round Performance*

This attribute measures team performance as part of an ALLIANCE.

Teams earn points based on how far their ALLIANCE advances in the Playoff MATCHES and the percentage of MATCH wins in which the team participated. The ALLIANCE Advancement points are shown in Table 11-8.

*Table 11-8 District Playoff Round Performance*

ALLIANCE Finish	ALLIANCE Advancement Points
Winner	30
Finalist	20
3 <sup>rd</sup> Place (loser of MATCH 13)	13
4 <sup>th</sup> Place (loser of MATCH 11)	7

In most cases, unless a BACKUP is recruited, a team plays in 100% of the Playoff MATCHES won by their ALLIANCE, thus their Playoff Round Performance points simply equals their ALLIANCE Advancement points. If a team does not play 100% of the Playoff MATCHES won by their ALLIANCE, their Playoff Round Performance points equals their ALLIANCE Advancement points multiplied by the percentage of Playoff MATCHES won by their ALLIANCE in which that team was a participant. For example, if Team X’s ALLIANCE wins the event, but Team X only played in 4 of the 5 Playoff MATCHES won by their ALLIANCE, Team X’s Playoff Round Performance points are  $30 \times (4/5) = 24$  points.

### 11.8.1.4 *Awards*

This attribute measures team performance with respect to team awards judged at the event.

The points earned for team awards in this system are not intended to capture the full value of the award to the team winning the award, or to represent the full value of the award to *FIRST*. In many ways, the team's experience in being selected for awards, especially the *FIRST* Impact Award, the Engineering Inspiration Award, and the Rookie All Star Award (which is optional for District Championship events), is beyond measure, and could not be fully captured in its entirety by any points-based system. Points are being assigned to awards in this system only to help teams recognize that *FIRST* continues to be "More than Robots<sup>SM</sup>," with the emphasis on our cultural awards, and to assist in elevating award-winning teams above non-award-winning teams in the ranking system.

Teams only get points for team awards judged at the event. If an award is not judged (e.g. Rookie Highest Seed), is not for a team (e.g. the Dean's List Award) or is not judged at the event (e.g. Safety Animation Award, sponsored by UL), no points are earned.

#### 11.8.1.5 Team Age

This attribute recognizes the difficulty in being a rookie or relatively new team.

Points are awarded to 2021, 2022, and 2023 rookie teams in recognition of the unique challenges teams face in those early years, and to increase the chance that they will make it to the District Championship to compete with their ROBOTS. Like our dedicated Rookie awards, these additional points are intended to recognize and motivate newer participants in *FIRST* Robotics Competition. These points are awarded once at the beginning of the season. Rookie year is calculated based on the year in which *FIRST* recognizes the team as a rookie.

#### 11.8.1.6 Regional Participation

District teams do not earn points for their actions at any Regionals they may attend, nor are eligible for *FIRST* Championship qualifying judged awards at those events. However, if a District team does earn a slot at the *FIRST* Championship while attending a Regional event, that slot does count as part of the total Championship allocation the District is receiving for the season.

---

## 11.8.2 District Championship Eligibility

A team competing in a District qualifies for their District Championship by meeting 1 of the following criteria:

- A. District *FIRST* Impact Award Winner,
- B. District Ranking (based on total points earned at their first 2 home District events as detailed in [Section 11.8.1 District Events](#)),

Teams do not earn points at third or subsequent District events, nor at any inter-district or Regional events at which they compete during the season.

If a team declines an invitation to the District Championship, the next highest uninvited team on the list is invited, and so on, until the event capacity is filled.

- C. District Engineering Inspiration winner (qualifies to compete for the award only), and
- D. District Rookie All Star winner (qualifies to compete for the award only).

The capacity of each District Championship is shown in Table 11-9. Each District determines the number of teams that qualify for their District Championship. These limits are based on factors including but not limited to the total number of teams in the District, available venue capacity, etc.

Table 11-9 2023 District Championship Capacities

District Championship	Capacity
<b>FIRST Chesapeake District Championship</b>	60
<b>FIRST Israel District Championship</b>	40
<b>FIRST Mid-Atlantic District Championship</b>	60
<b>FIRST North Carolina State Championship</b>	36
<b>FIRST Ontario Provincial Championship</b>	80
<b>FIRST in Texas District Championship</b>	80
<b>Indiana State Championship</b>	32
<b>Michigan State Championship</b>	160
<b>New England District Championship</b>	90
<b>Pacific Northwest District Championship</b>	50
<b>Peachtree District State Championship</b>	50

### 11.8.3 District Championships with Multiple Divisions

Some District Championships have a sufficient number of teams to justify using more than 1 division. Teams are assigned divisions by *FIRST* using a process developed by *FIRST* in Michigan.

The process employs a “brute force iterative randomizer” and is executed as follows:

1. The district team list is sorted in order of cumulative district points earned as described in [Section 11.8.1 District Events](#).
2. The list is divided into quartiles based on rank (e.g. the first quartile has the top 25% ranked teams).
3. Division assignments are randomly generated using equal contribution from each quartile.
4. 3 criteria are calculated for each division:
  - a. average strength: the arithmetic mean of the district point values of teams in a division
  - b. distribution of strength: the Signal to Noise Ratio (SNR) of the district point values of teams in a division. SNR is calculated as follows:

$$SNR = 10 \left( \log \frac{\bar{x}^2}{\sigma^2} \right)$$

$\bar{x}$  = arithmetic mean of the district points in a division

$\sigma$  = standard deviation of the district points in a division

- c. distribution of strength for “top” teams: The SNR of the district point values of teams in the first quartile of a division
5. The 3 criteria for each division are compared to the other division(s). If the difference between the division’s value and any other division’s value exceeds the limits in Table 11-10, the criteria is not met.



Table 11-10 District Championship division Evaluation Limits

	2 divisions	4 divisions
Average strength	1	2
Distribution of strength	1	2.5
Distribution of strength for "top" teams	1.5	2

- If all 3 criteria met, event organizers publish the assignments. If any of the 3 criteria are not met, assignments are rejected, and the process returns to Step 3.

### 11.8.3.1 District Championship Playoffs

In these cases:

- Division winning ALLIANCES play each other in District Championship Playoffs, employing the bracket below that corresponds to their District, until a winning ALLIANCE for the event is determined.

Figure 11-4 4 division District Championship Playoff Bracket

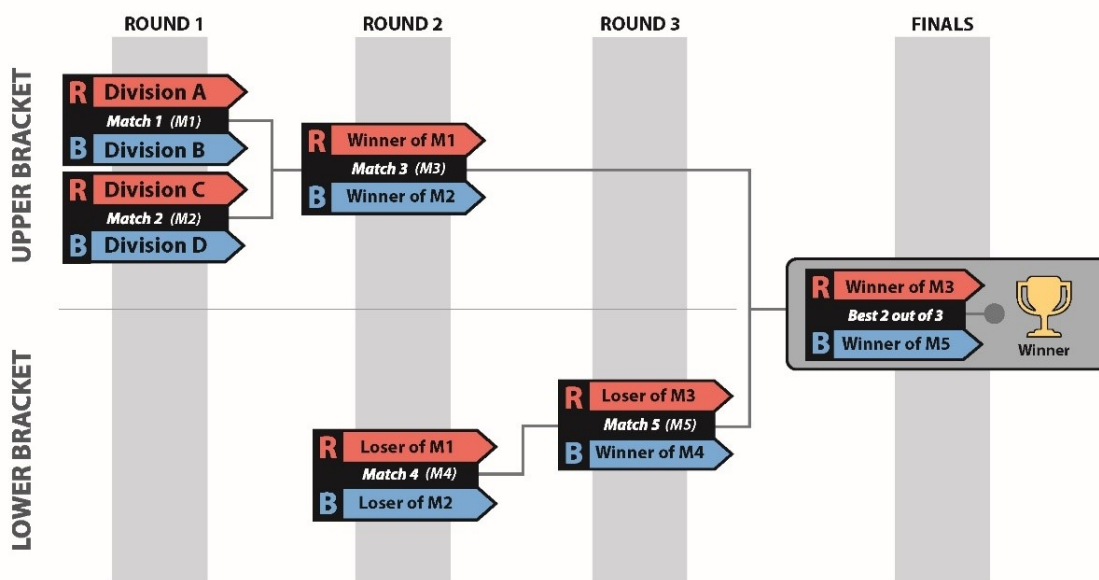
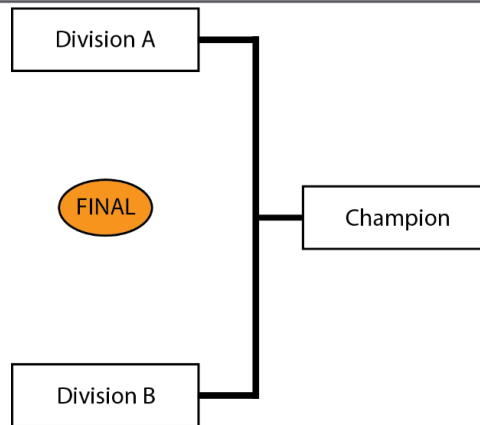

Figure 11-5 2 division District Championship Playoff Bracket



- Each team on a Champion ALLIANCE of a 2-Division District Championship Playoff tournament earns 10 points.
- For a 4-Division District Championship Playoff tournament, each team on a Champion ALLIANCE earns 20 points and each team on a Finalist ALLIANCE receives 10 points.
- If any of these alliances has recruited a BACKUP TEAM, these points are divided amongst the teams as described in [Section 11.8.1.3 Playoff Round Performance](#).
- If an ALLIANCE in a District Championship Playoff has not yet recruited a BACKUP TEAM per [Section 11.7.3 BACKUP TEAMS](#), the ALLIANCE CAPTAIN may bring in only the highest ranked team from their division’s BACKUP POOL to join its ALLIANCE.

## 11.9 FIRST Championship: Additions and Exceptions

At the 2023 *FIRST* Championship, teams are split into 8 divisions. The process used to assign teams to their division is as follows:

1. Rookies are assigned randomly, team by team, sequentially to divisions (i.e. a team in Division 1, a team in Division 2, a team in Division 3, a team in Division 4, a team in Division 5, a team in Division 6, a team in Division 7, a team in Division 8, then back to Division 1 again, until Rookies are all assigned to a division).
2. Step 1 is repeated with veteran teams.

Each division plays a standard tournament as described in [Section 11.6 Qualification MATCHES](#) and [Section 11.7 Playoff MATCHES](#) to produce the division Champions. Those 8 division Champions proceed to the Championship Playoffs, on the Einstein FIELDS, to determine the 2023 *FIRST* Robotics Competition Championship Winners, per [Section 11.9.4 FIRST Championship Playoffs](#).

### 11.9.1 Advancement to the *FIRST* Championship

Details on how teams earn eligibility to attend the *FIRST* Championship are posted on the [FIRST Championship eligibility webpage](#).

### 11.9.2 4 ROBOT ALLIANCES

There is no provision for BACKUP TEAMS at the *FIRST* Championship.

Instead, before each division Playoff Tournament, ALLIANCES are selected per the process as described in [Section 11.7.1 ALLIANCE Selection Process](#), however the process continues with a third round of selection as follows.

---

**Round 3:** The same method is used for each ALLIANCE CAPTAIN'S third choice except the selection order is reversed again, with ALLIANCE 1 picking first and ALLIANCE 8 picking last. This process results in 8 ALLIANCES of 4 teams each.

ALLIANCES may start with any 3 of the 4 ROBOTS on their ALLIANCE during division Playoff MATCHES and during the Championship Playoffs. ALLIANCES submit LINEUPS for their MATCHES as described in [Section 11.7.4 LINEUPS](#).

---

### 11.9.3 *FIRST* Championship Pit Crews

*FIRST* distributes buttons to the ALLIANCE CAPTAINS during the ALLIANCE CAPTAIN meeting, which takes place on the division FIELDS. These buttons provide the necessary access to the ARENA for pit crew members.

**T901** \*Wear your buttons. Only team members wearing proper buttons are allowed on the ARENA floor during division and Playoff MATCHES.

*Violation: MATCH won't start until the situation is corrected. Those not displaying identification must leave the ARENA.*

Teams should assume they may be chosen for an ALLIANCE and think about the logistics of button distribution and set a plan prior to the ALLIANCE selection process. It is each ALLIANCE CAPTAIN'S responsibility to distribute buttons to their pit crew members.

---

### 11.9.4 *FIRST* Championship Playoffs

The 8 division Champions play a Double Elimination style tournament as described in [Section 11.7 Playoff MATCHES](#) to determine the 2023 *FIRST* Robotics Competition Champions. Exact MATCH timing is provided to *FIRST* Championship Playoff teams. ALLIANCES are paired as shown in Figure 11-6.

Figure 11-6 Championship Playoff Bracket

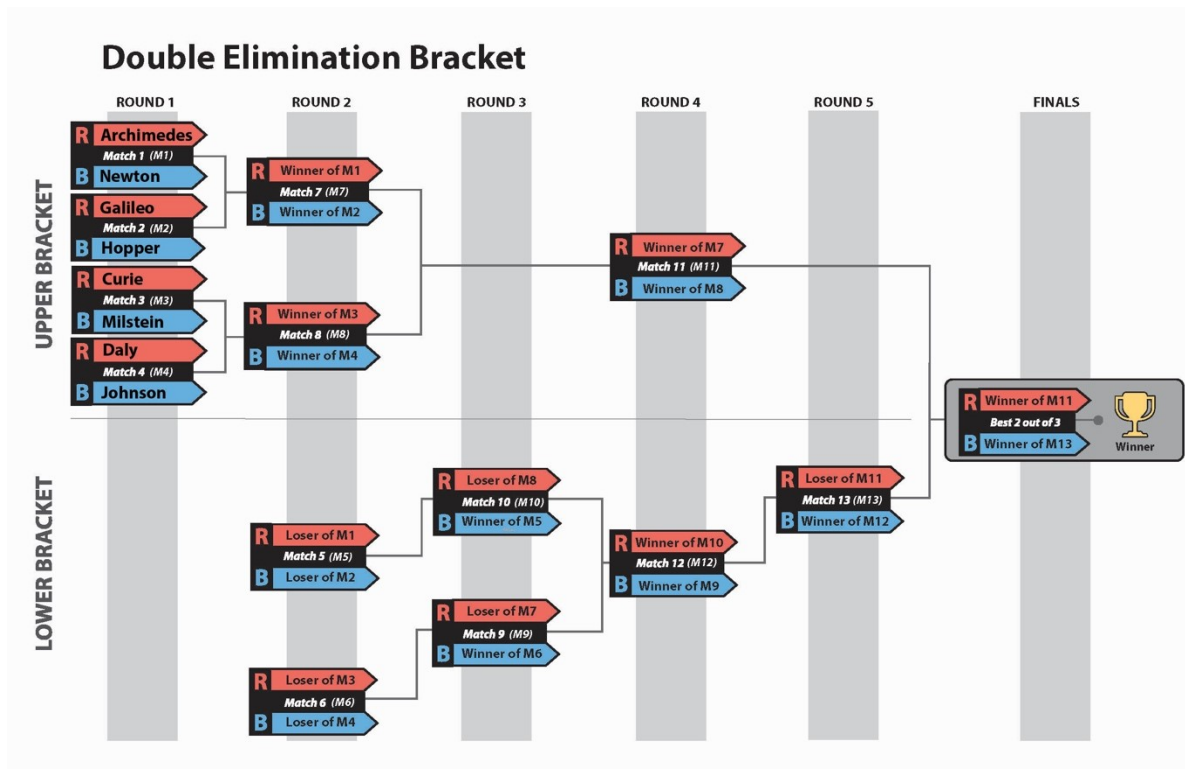

During the Einstein Finals, if the MATCH score of each ALLIANCE is equal, the MATCH is replayed. In this circumstance, the LINEUP may be changed.



## 12 GLOSSARY

Term	Definition
<b>ACTIVATION BONUS</b>	At least 26 total CHARGE STATION points earned in AUTO and/or ENDGAME
<b>ACTIVE DEVICE</b>	any device capable of dynamically controlling and/or converting a source of electrical energy by the application of external electrical stimulus
<b>ALLIANCE</b>	a cooperative of up to 4 FIRST Robotics Competition teams
<b>ALLIANCE CAPTAIN</b>	The designated STUDENT representative from each ALLIANCE Lead
<b>ALLIANCE AREA</b>	a 20 ft. (~609 cm) wide by 9 ft. 10¼ in. (~300 cm) deep infinitely tall volume formed by, and including the ALLIANCE WALL, the edge of the carpet, and ALLIANCE colored tape
<b>ALLIANCE WALL</b>	an ARENA element that <b>Error! Reference source not found.</b>
<b>ARENA</b>	a space which includes all elements of the game infrastructure that are required to play CHARGED UP <sup>SM</sup> presented by Haas: the FIELD, GAME PIECES, and all equipment needed for FIELD control, ROBOT control, and scorekeeping.
<b>ARENA FAULT</b>	an error in ARENA operation
<b>AUTO</b>	The first phase of each MATCH is 15 seconds long and called the Autonomous Period (AUTO). During AUTO, ROBOTS operate without any DRIVE TEAM control or input
<b>BACKUP TEAM</b>	The team whose ROBOT and DRIVE TEAM replaces another ROBOT and DRIVE TEAM on an ALLIANCE during the Playoff MATCHES
<b>BACKUP POOL</b>	the group of teams willing and able to join an ALLIANCE during the Playoff MATCHES, if needed, until up to 8 teams accept
<b>BARRIER</b>	a 7 ft. 4 in. (~224 cm) long assembly that separates each COMMUNITY from its adjacent LOADING ZONE
<b>BUMPER</b>	a required assembly which attaches to the ROBOT frame. BUMPERS protect ROBOTS from damaging/being damaged by other ROBOTS and FIELD elements
<b>BUMPER ZONE</b>	the volume contained between the floor and a virtual horizontal plane 7½ in. (~19 cm) above the floor in reference to the ROBOT standing normally on a flat floor
<b>BYPASSED</b>	the state assigned to any ROBOT which is unable or ineligible to participate in that MATCH, as determined by the FTA, LRI, or Head REFEREE
<b>CENTER LINE</b>	a white tape line that bisects the length of the FIELD.

Term	Definition
<b>CHARGE STATION</b>	an 8 ft. 1¼ in. (~247 cm) wide, 6 ft. 4⅞ in. (~193 cm) deep structure that is located in each COMMUNITY such that its center is 8 ft. 2⅝ in. (~251 cm) from the far edge of the GRID'S tape line and centered in the width of the COMMUNITY
<b>COACH</b>	a guide or advisor
<b>COMMUNITY</b>	an 18 ft. (~549 cm) wide by 11 ft. ⅜ in. (~336 cm) to 16 ft. 1¼ in. (~491 cm) deep infinitely tall volume formed by the ALLIANCE WALL, the plane defined by the BARRIER plastic, ALLIANCE colored tape, and the guardrail. an 18 ft. (~549 cm) wide by 11 ft. ⅜ in. (~336 cm) to 16 ft. 1¼ in. (~491 cm) deep infinitely tall volume formed by the ALLIANCE WALL, the plane defined by the BARRIER plastic, ALLIANCE colored tape, and the guardrail. an 18 ft. (~549 cm) wide by 11 ft. ⅜ in. (~336 cm) to 16 ft. 1¼ in. (~491 cm) deep infinitely tall volume formed by the ALLIANCE WALL, the plane defined by the BARRIER plastic, ALLIANCE colored tape, and the guardrail.
<b>COMPONENT</b>	any part in its most basic configuration, which cannot be disassembled without damaging or destroying the part or altering its fundamental function
<b>CONTINUOUS</b>	describes rule violations that happen for more than approximately 10 seconds
<b>CONTROL</b>	the state of a GAME PIECES if any of the following are true: A. the GAME PIECE is fully supported by the ROBOT, or B. the ROBOT is intentionally moving a GAME PIECE to a desired location or in a preferred direction C.
<b>CONE</b>	a yellow 1 ft. 13/16 in. (~33 cm) tall rubber marker cone
<b>CONE NODE</b>	a 1¼ in. Schedule 40 (1.66 in. (~4 cm) outer diameter) aluminum pipe with a plug installed in the top
<b>COOPERTITION BONUS</b>	At least 3 GAME PIECES scored on each ALLIANCE'S CO-OP GRID
<b>COTS</b>	an adjective that describes a standard (i.e. not custom order) part commonly available from a VENDOR for all teams for purchase
<b>CUSTOM CIRCUIT</b>	Any active electrical item that is not an actuator (specified in R501) or core control system item (specified in R710)
<b>CUBE</b>	cube-like shape, inflated to 9 ½ in. (~24 cm) +/- ¼ in. (~6 mm) as measured from face to face
<b>CUBE NODE</b>	a polycarbonate shelf that is 1 ft. 6¼ in. (~46 cm) wide and 1 ft. 5 in. (~43 cm) deep.
<b>DISABLED</b>	the state in which a ROBOT is commanded to deactivate all outputs, rendering the ROBOT inoperable



Term	Definition
<b>DISQUALIFIED</b>	the state of a team in which they receive 0 MATCH points and 0 Ranking Points in a Qualification MATCH or causes their ALLIANCE to receive 0 MATCH points in a Playoff MATCH
<b>DOCKED</b>	The state of the ROBOT if it is contacting only the CHARGE STATION and/or other items also directly or transitively fully supported by the CHARGE STATION.
<b>DOUBLE SUBSTATION</b>	A SUBSTATION in-line with their opponent's ALLIANCE WALL.
<b>DRIVER</b>	an operator and controller of the ROBOT
<b>DRIVER STATION</b>	<b>Error! Reference source not found.</b>
<b>DRIVE TEAM</b>	a set of up to 5 people from the same <i>FIRST</i> Robotics Competition team responsible for team performance for a specific MATCH
<b>ENGAGED</b>	The state of the ROBOT if the following are true: A. the CHARGE STATION is LEVEL, and B. all ALLIANCE ROBOTS contacting the CHARGE STATION are DOCKED.
<b>FABRICATED ITEM</b>	any COMPONENT or MECHANISM that has been altered, built, cast, constructed, concocted, created, cut, heat treated, machined, manufactured, modified, painted, produced, surface coated, or conjured partially or completely into the final form in which it will be used on the ROBOT
<b>FIELD</b>	an approximately 26 ft. 3½ in. (~802 cm) by 54 ft. 3¼ in. (~1654 cm) carpeted area bound by and including the inward- and upward-facing surfaces of the guardrails, inward-facing surfaces of the ALLIANCE WALLS, inward-facing surfaces of the SINGLE SUBSTATION (excluding the PORTALS), and the outermost vertical and diagonal polycarbonate surfaces of the DOUBLE SUBSTATION (excluding the PORTALS)
<b>FIELD STAFF</b>	REFEREES, FTAs, or other staff working around the FIELD
<b>FMS</b>	<b>Error! Reference source not found.</b>
<b>FOUL</b>	a credit of 5 points towards the opponent's MATCH
<b>FRAME PERIMETER</b>	fixed, non-articulated structural elements of the ROBOT contained within the BUMPER ZONE
<b>FTA</b>	a <i>FIRST</i> Technical Advisor
<b>GAME PIECES</b>	CONES and CUBES
<b>GRID</b>	a 3 ft. 10 in. (~117 cm) tall, 4 ft. 6¼ in. (~138 cm) deep assembly that includes the ALLIANCE colored tape line
<b>HUMAN PLAYER</b>	a GAME PIECE manager

Term	Definition
<b>HYBRID NODE</b>	1 ft. 4 in. (~41 cm) deep carpeted surface contained within the GRID.
<b>INSPECTOR</b>	a volunteer employed to accurately and efficiently assess the legality of a given part or ROBOT
<b>KOP</b>	Kit of Parts, the collection of items listed on the current season's Kickoff Kit Checklists, distributed to the team via <i>FIRST</i> Choice in the current season, or paid for completely (except shipping) with a Product Donation Voucher (PDV) from the current season
<b>LEVEL</b>	A CHARGE STATION within approximately 2½° of parallel to FIELD carpet
<b>LINEUP</b>	the list of the 3 teams participating in the MATCH and their selected DRIVER STATIONS
<b>LINK</b>	3 adjacent NODES in a ROW contains a scored GAME PIECE
<b>LRI</b>	a Lead ROBOT INSPECTOR
<b>MAJOR MECHANISM</b>	a group of COMPONENTS and/or MECHANISMS assembled together to address at least 1 game challenge: ROBOT movement, GAME PIECES manipulation, FIELD element manipulation, or performance of a scorable task without the assistance of another ROBOT
<b>MATCH</b>	a two minute and 30 second period of time in which ALLIANCES play CHARGED UP
<b>MECHANISM</b>	an assembly of COMPONENTS that provide specific functionality on the ROBOT
<b>MOBILITY</b>	The award given to a ROBOT whose BUMPERS have completely left its COMMUNITY at any point during AUTO
<b>MOMENTARY</b>	describes rule violations that happen for fewer than approximately 3 seconds
<b>MPX</b>	myRIO Expansion port, the expansion port on the roboRIO
<b>NODE</b>	1 of 9 GAME PIECE scoring locations within a GRID
<b>OPERATOR CONSOLE</b>	the set of COMPONENTS and MECHANISMS used by the DRIVERS and/or HUMAN PLAYERS to relay commands to the ROBOT
<b>PASSIVE CONDUCTOR</b>	any device or circuit whose capability is limited to the conduction and/or static regulation of the electrical energy applied to it (e.g. wire, splices, connectors, printed wiring board, etc.)
<b>PH</b>	a Pneumatic Hub
<b>PCM</b>	a Pneumatic Control Module
<b>PDH</b>	a Power Distribution Hub
<b>PDP</b>	a Power Distribution Panel

Term	Definition
<b>PIN</b>	the act in which a ROBOT is preventing the movement of an opponent ROBOT by contact, either direct or transitive (such as against a FIELD element)
<b>PORTAL</b>	a three-dimensional volume through which humans transfer GAME PIECES to ROBOTS or the FIELD
<b>RED CARD</b>	a penalty assessed for egregious ROBOT or team member behavior or rule violations which results in a team being DISQUALIFIED for the MATCH
<b>REFEREE</b>	an official who is certified by FIRST to enforce the rules of CHARGED UP
<b>REPEATED</b>	describes rule violations that happen more than once within a MATCH
<b>ROBOT</b>	an electromechanical assembly built by the FIRST Robotics Competition team to play the current season’s game and includes all the basic systems required to be an active participant in the game –power, communications, control, BUMPERS, and movement about the FIELD
<b>ROW</b>	a series of 9 horizontally adjacent NODES where GAME PIECES can be scored for a common number of points
<b>RP</b>	a Ranking Point
<b>RPM</b>	a Radio Power Module
<b>RS</b>	the Ranking Score
<b>RSL</b>	a ROBOT Signal Light
<b>SIGNAL LEVEL</b>	circuits which draw $\leq 1A$ continuous and have a source incapable of delivering $>1A$ , including but not limited to roboRIO non-PWM outputs, CAN signals, PCM/PH Solenoid outputs, VRM 500mA outputs, RPM outputs, and Arduino outputs)
<b>STAGING MARK</b>	1 of 8 marks used to identify starting locations for GAME PIECES
<b>STARTING CONFIGURATION</b>	the physical configuration in which a ROBOT starts a MATCH
<b>STARTING LINE</b>	a white tape line spanning the ALLIANCE AREA and SUBSTATION AREA located 2 ft. 4 in. (~71 cm) from the face of THE ALLIANCE WALL to the near edge of the tape.
<b>STUDENT</b>	a person who has not completed high-school, secondary school, or the comparable level as of September 1 prior to Kickoff
<b>SINGLE SUBSTATION</b>	a SUBSTATION in-line with the guardrail.

Term	Definition
<b>SUBSTATION</b>	an assembly used to move GAME PIECES from humans to ROBOTS or onto the FIELD. There are 2 types of SUBSTATIONS in each SUBSTATION AREA: a SINGLE SUBSTATION and a DOUBLE SUBSTATION.
<b>SURROGATE</b>	a team randomly assigned by the FIELD Management System to play an extra Qualification MATCH
<b>SUSTAINABILITY BONUS</b>	At least 5 LINKS scored.
<b>TECH FOUL</b>	a credit of 12 points toward the opponent’s MATCH
<b>TECHNICIAN</b>	a resource for ROBOT troubleshooting, setup, and removal from the FIELD
<b>TELEOP</b>	The second phase of each MATCH lasting two minutes and fifteen seconds (2:15) during which DRIVERS remotely operate ROBOTS to retrieve and score GAME PIECES
<b>VENDOR</b>	a legitimate business source for COTS items that satisfies all criteria listed in ROBOT Construction Rules
<b>VRM</b>	a Voltage Regulator Module
<b>YELLOW CARD</b>	a warning issued by the Head REFEREE for egregious ROBOT or team member behavior or rule violations. A subsequent YELLOW CARD within the same tournament phase results in a RED CARD





FIRST® ENERGIZE<sup>SM</sup>  
presented by Qualcomm

---

FIRST®, the FIRST® logo, FIRST® Robotics Competition, FIRST® Tech Challenge, CHARGED UP<sup>SM</sup>, FIRST ENERGIZE<sup>SM</sup>, Gracious Professionalism®, and Coopertition® are trademarks of For Inspiration and Recognition of Science and Technology (FIRST). LEGO® is a trademark of the LEGO Group. FIRST® LEGO® League is a jointly held trademark of FIRST and the LEGO Group. All other trademarks are the property of their respective owners. ©2023 FIRST. All rights reserved.